



britax
safe·n·sound

EXPANDABLE BOOSTER SEAT

Series No. BS4830A-020132

Instructions for Installation & Use

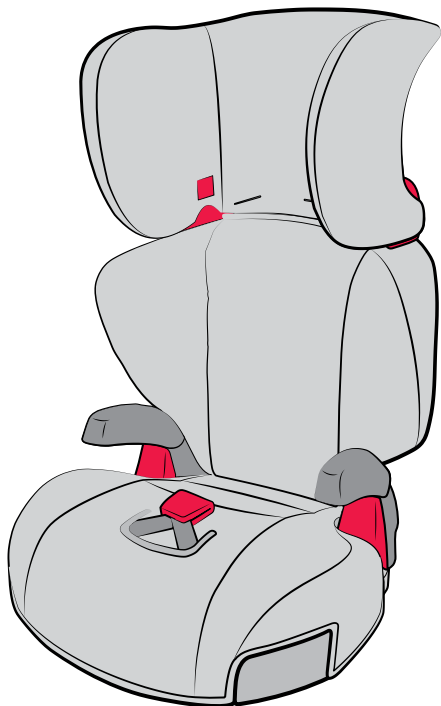

**FORWARD
FACING**

4 years to
6-8 years
(approx).



**IMPORTANT: KEEP THIS BOOKLET IN THE
PLACE PROVIDED ON THE CHILD RESTRAINT**



SEATBELT QUICK SETUP

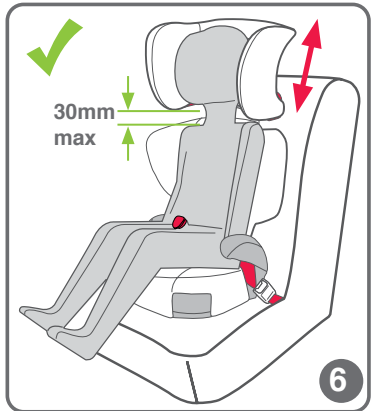
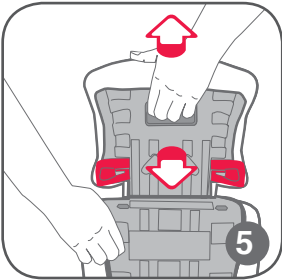
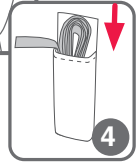
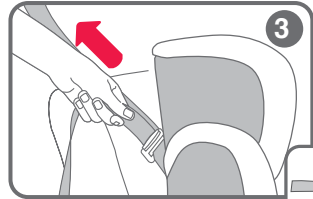
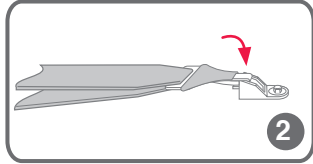
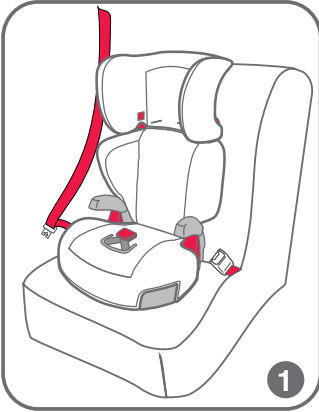

SEATBELT QUICK SETUP

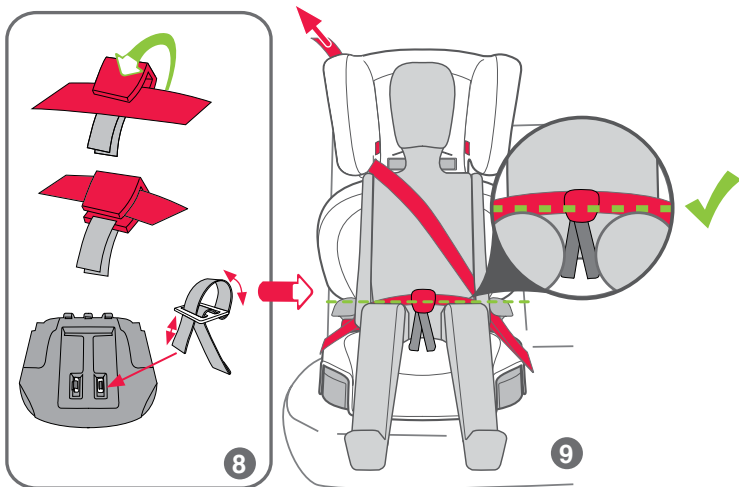
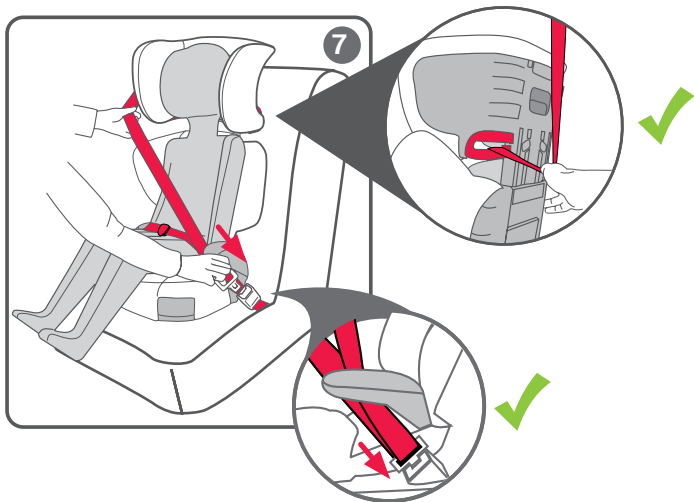



INTRODUCTION

To be used with a lap-sash seatbelt by a child whose shoulders are above the lower shoulder height marker with head restraint in lowest position (approximately 4 years of age) until the child's shoulders reach the upper shoulder height marker with head restraint in highest position (approximately 6 to 8 years of age).

Can also be used with child harness that is approved for use with this booster seat.

Continue to use this booster seat until the child reaches this limit. Children are safest in a booster seat until their shoulders reach the upper shoulder height marker of the booster seat.

Do not use this restraint until child's shoulders are above the lower shoulder height marker with the head restraint in the lowest position.

If the knees do not bend in front of the vehicle seat cushion continue to use a booster seat.

Just using a seatbelt is not recommended for children that have outgrown this seat. Use a larger booster seat.

Gamitin kasama ang isang lap-sash na seatbelt ng isang bata na ang mga balikat ay lampas na sa ibabang marka ng taas ng balikat (humigit-kumulang 4 na taong gulang) hanggang sa maabot ng mga balikat ng bata ang itaas na marka ng taas sa balikat (humigit-kumulang 6-8 taong gulang).

Maaari ring gamitan ng guwarnisyon ng bata na naaprubahang gamitin kasama ang upuang booster na ito.

Patuloy na gamitin ang upuang booster na ito hanggang sa maabot ng bata ang limitasyong ito. Ang mga bata ay pinakaligtas sa isang upuang booster hanggang sa maabot ng kanilang mga balikat ang itaas na marka ng taas ng balikat ng upuang booster.

Huwag gamitin ang pampigil na ito hanggang sa ang mga balikat ng bata ay lampas na sa ibabang marka ng taas ng balikat at kung saan ang pampigil ng ulo ay nasa pinakamababang posisyon.

Kung ang mga tuhod ay hindi makaliko sa harap ng kutson ng upuan ng sasakyan ay patuloy na gamitin ang upuang booster.

Ang paggamit lamang ng seatbelt ay hindi inirekomenda para sa mga bata na nakalakhan na upuang ito. Gumamit ng isang mas malaking upuang booster.

肩膀超过靠下肩高标记的儿童需配备安全腰带，头枕放在最低的位置（大约4岁的儿童），直到儿童的肩膀达到靠上的肩高标记，头枕放在最高的位置（大约6-8岁的儿童）。

也可以和垫高椅匹配的儿童安全带一起使用。

在儿童达到垫高椅上限之前必须使用垫高椅。在儿童肩膀达到垫高椅靠上的肩高标记之前最安全的做法是使用垫高椅。

在儿童肩膀超过靠下的肩高标记前不得使用该安全座椅，头枕放在最低的位置。

如果儿童在车辆弹性座垫前无法自然屈膝则需要继续使用垫高椅。

不建议个子比该座椅大的儿童只使用安全带，要使用较大的垫高座椅。

INTRODUCTION

Được sử dụng với dây nịt an toàn quàng qua vai của em nào có vai trên vạch ghi độ cao của vai ở dưới cùng có phần kim đầu ở vị trí thấp nhất (khoảng 4 tuổi) cho đến khi vai của em cao tới vạch ghi độ cao có phần kim đầu ở vị trí cao nhất (khoảng 6-8 tuổi).

Cũng có thể được sử dụng với đai nịt trẻ em được chấp thuận sử dụng với ghế trẻ em (booster) này.

Hãy tiếp tục sử dụng ghế trẻ em (booster) này cho đến khi em cao tới giới hạn này. Trẻ em được an toàn nhất trong ghế trẻ em cho đến khi vai của em cao tới vạch ghi độ cao của vai ở trên cùng của ghế trẻ em.

Không sử dụng ghế em bé này cho đến khi vai của em ở trên vạch ghi độ cao của vai ở dưới cùng có phần kim đầu ở vị trí thấp nhất.

Nếu đầu gối không có lại đằng trước đệm ghế xe, hãy tiếp tục sử dụng ghế trẻ em (booster).

Chỉ sử dụng dây nịt an toàn không được đề nghị cho các em lớn hơn ghế này. Hãy sử dụng ghế trẻ em (booster) rộng hơn.

केवल उस शिशु द्वारा लेप-सेश सीटबेल्ट के साथ प्रयोग किया जाना चाहिए जिसके कन्धे कन्धे के नचिले भाग से ऊपर आ गए हों (लगभग 4 वर्ष की आयु पर) और तब तक जब तक कि शिशु के कन्धे कन्धे के ऊपरी भाग के चनिह तक न पहुँच जाएँ व सरि परतबिन्ध सबसे उच्च स्थिति में हो (लगभग 6 से 8 वर्ष की आयु पर)।

शिशु हार्नस के साथ प्रयोग भी किया जा सकता है जो बूस्टर सीट के साथ प्रयोग के लिए अनुमोदित हो। बूस्टर सीट को तब तक प्रयोग करते रहें जब तक कि शिशु सीमा तक न पहुँचें। शिशु बूस्टर सीट में तब तक सबसे अधिक सुरक्षित होते हैं जब तक कि उनके कन्धे बूस्टर सीट के कन्धों के उपरी चनिह तक न पहुँचें।

बूस्टर सीट का प्रयोग तब तक न करें जब तक कि शिशु के कन्धे बूस्टर सीट पर कन्धों के नचिले चनिह को पार न करें।

अगर घुटने गाड़ी के सीट के गद्दे पर आगे न मुड़े तो बूस्टर सीट का प्रयोग जारी रखें।

जनि शिशुओं की आयु इस सीट के लिए उचित आयु से अधिक हो गई हो उनके लिए मात्र सीटबेल्ट के प्रयोग का सुझाव नहीं दिया जाता है। बड़ी बूस्टर सीट का प्रयोग करें।

Da usare con una cintura di sicurezza fasciante dal bambino le cui spalle sono sopra il marcatore di altezza inferiore con il poggiatesta in posizione più bassa (circa 4 anni di età) fino a quando le spalle del bambino raggiungono il marcatore superiore di altezza con il poggiatesta in posizione più alta (circa 6 a 8 anni di età).

Questo seggiolino può essere utilizzato anche con un'imbracatura per bambini approvata per l'uso.

Continuare a utilizzare questo seggiolino fino a quando il bambino raggiunge questo limite. I bambini sono più sicuri su un seggiolino finché le loro spalle raggiungono il marcatore di altezza superiore del seggiolino.

Non utilizzare questo sistema di ritenuta fino a quando le spalle del bambino sono al di sopra del marcatore di altezza inferiore con il poggiatesta nella posizione più bassa.

Se le ginocchia non si piegano al limite del sedile del veicolo continuare ad utilizzare un seggiolino. Usare soltanto la cintura di sicurezza non è raccomandato per i bambini che sono troppo grandi per questo sedile. Utilizzare un seggiolino più grande.



INTRODUCTION

يتم استخدامه مع حزام أمان الكتف والخصر للطفل الذي تجاوز كتفيه علامة ارتفاع الأكتاف السفلية في حين وضع حاجز الرأس في أدنى وضعية (تقريباً في عمر 4 سنوات) حتى يصل كتفي الطفل إلى علامة ارتفاع الأكتاف العلوية (في حين وضع حاجز الرأس في أعلى وضعية (تقريباً في عمر 6 إلى 8 سنوات). يمكن استخدامه أيضاً مع أحزمة تثبيت الأطفال المستحسنة للاستخدام مع مقعد الأمان المرتفع هذا. استمر في استخدام مقعد الأمان المرتفع هذا لحين وصول الطفل إلى هذا الحد. يكون الأطفال أكثر أماناً في مقعد أمان مرتفع حتى تصل أكتافهم إلى علامة ارتفاع الأكتاف العلوية لمقعد الأمان المرتفع. لا تستخدم مقعد الأمان المرتفع هذا إلا عندما يكون كتفي الطفل أعلى من علامة ارتفاع الأكتاف السفلية في حين وضع حاجز الرأس في أدنى وضعية. إذا كانت الركبتين لا تنتهيان أمام وسادة كرسي السيارة، استمر في استخدام مقعد أمان مرتفع. لا نوصي بمجرد استخدام حزام الأمان للأطفال الذين كُبر حجمهم عن هذا المقعد. استخدم مقعد أمان مرتفع ذو مقياس أكبر.

Na χρησιμοποιείται με μία ζώνη ασφαλείας τριών σημείων από ένα παιδί οι ώμοι του οποίου είναι πάνω από τον κατώτερο δείκτη ύψους ώμου με το προσκέφαλο στη χαμηλότερη θέση (περίπου 4 ετών) μέχρι οι ώμοι του παιδιού να φτάσουν στον ανώτερο δείκτη ύψους ώμου με το προσκέφαλο στην υψηλότερη θέση (περίπου 6 έως 8 ετών). Μπορεί επίσης να χρησιμοποιηθεί με τον παιδικό ιμάντα που έχει εγκριθεί για χρήση με αυτό το βοηθητικό κάθισμα. Συνεχίστε να χρησιμοποιείτε αυτό το βοηθητικό κάθισμα μέχρι το παιδί να φτάσει σε αυτό το όριο. Τα παιδιά είναι ασφαλέστερα σε ένα βοηθητικό κάθισμα μέχρι οι ώμοι τους να φθάνουν στον ανώτερο δείκτη ύψους ώμου του βοηθητικού καθίσματος. Μην χρησιμοποιείτε αυτή τη διάταξη συγκράτησης μέχρι οι ώμοι του παιδιού να είναι πάνω από τον κατώτερο δείκτη ύψους ώμου με το προσκέφαλο στην χαμηλότερη θέση. Αν τα γόνατα δεν λυγίζουν μπροστά από το μαξιλάρι καθίσματος του οχήματος, συνεχίστε να χρησιμοποιείτε ένα βοηθητικό κάθισμα. Η χρήση μόνον μιας ζώνης ασφαλείας δεν συνιστάται για παιδιά που έχουν ξεπεράσει σε ύψος αυτό το κάθισμα. Χρησιμοποιήστε ένα μεγαλύτερο βοηθητικό κάθισμα.#

應與安全腰帶一同使用，適用於肩膀超過靠下的肩高標記的孩子（大約4歲大），直至其肩膀達到靠上的肩高標記（大約6至8歲大）。也可同與此座椅匹配的兒童安全背帶一並使用。讓您的孩子一直乘坐墊高椅，直至其達到墊高椅的上限。在孩子肩膀達到墊高椅靠上的肩高度標記之前，使用墊高椅是最安全的做法。在孩子肩膀超過靠下的肩高標記且其頭部可靠到頭枕的最低位置之前，切勿使用此座椅。若孩子在汽車座椅邊無法自然曲膝，請繼續使用墊高椅。孩子因長大超出墊高椅的上限時，不推薦僅僅使用安全帶。請使用更大尺寸的墊高椅。



INTRODUCTION

Debe utilizarse con un cinturón de seguridad de tres puntos para un niño cuyos hombros sobrepasen el marcador inferior con el reposacabezas en la posición más baja (aproximadamente a los 4 años de edad) hasta que los hombros del niño alcancen el marcador superior con el reposacabezas en la posición más alta (aproximadamente a los 6 a 8 años de edad).

También se puede utilizar con el arnés para niños cuyo uso con este asiento elevador esté aprobado.

Siga usando este asiento elevador hasta que el niño alcance dicho límite. El niño estará más seguro en un asiento elevador hasta que sus hombros alcancen el marcador de altura superior del asiento elevador.

No utilice este sistema de seguridad hasta que los hombros del niño no sobrepasen el marcador inferior de con el reposacabezas en la posición más baja.

Si las rodillas del niño no se doblan en la parte delantera del cojín del asiento del vehículo siga utilizando un asiento elevador.

No se recomienda utilizar sólo un cinturón de seguridad para el niño que ya no quepa en este asiento. Utilice un asiento elevador más grande.



INTRODUCTION

Carefully read all the instructions for installation. If in doubt about the method of installation, consult Britax Childcare or agent or a child restraint fitter or, in New Zealand, consult the agent for the vehicle.

This Booster Seat is fitted with the VERSATETHER™ catch that allows it to be used with a child harness.

Suitable for use with a Britax™ Safe-n-Sound Protecta PLUS™ Child Harness Series 220/2013

A child who is not tall enough to reach the upper shoulder height marker in their seat with in-built harness may be too small for this booster seat. This booster seat should be used until the child no longer fits in this seat or the child can sit in the car's seat with their lower leg able to hang over the car's seat cushion.

A child harness **MUST** be used with this Booster seat if the seating position chosen has a Lap only seat belt.

Regional traffic laws may restrict the use of this booster seat in front seat of the car. Check your local laws.

This booster seat is not designed to be reclined but may fit vehicle seats with different seatback angles.

THIS RESTRAINT MUST BE USED IN CARS WITH FORWARD-FACING SEATS WITH A LAP-SASH SEATBELT OR WITH A SEATBELT AND CHILD HARNESS.

THIS RESTRAINT MUST BE ATTACHED TO A CHILD RESTRAINT UPPER ANCHORAGE POINT IN THE CAR. REFER TO CAR OWNER'S HANDBOOK FOR LOCATION OF UPPER ANCHORAGE POINTS. REFER TO A CHILD RESTRAINT FITTING STATION IF NO UPPER ANCHORAGE POINTS ARE IN THE MOTOR CAR.

No child restraint can guarantee absolute protection from injury in every crash. However, to ensure that your child gets all the protection designed into the restraint **PLEASE READ AND FOLLOW THESE INSTRUCTIONS EXACTLY.**

This child restraint is not suitable for use on an aircraft.

For future reference always store the instruction book in the pocket provided on the side of the restraint.



PAGE

- 10** WARNINGS
- 12** SHOULDER HEIGHT MARKERS AND A GROWING CHILD
- 13** SHOULDER HEIGHT MARKERS
- 14** SPECIAL FEATURES
- 16** HOW TO SETUP
- 18** HOW TO INSTALL
- 20** HOW TO USE
- 24** HOW TO USE WITH A CHILD HARNESS
- 36** HOW TO REMOVE RESTRAINT FROM VEHICLE
- 37** CARE & MAINTENANCE
- 38** HOW TO CLEAN
- 40** ACCESSORIES
- 41** INSTALLATION OF CARS UPPER ANCHORAGE POINT
- 44** IN CASE OF CRASH
- 48** WARRANTY



WARNINGS

- **DO NOT USE WITH JUST A LAP BELT.** You must use with a lap-sash seat belt, or with a seat belt and child harness.
- The lap part of the seat belt must be firmly across the thighs and the sash belt fitted diagonally across the chest and on the shoulder.
- If used with a child harness, the lap belt must be adjusted firmly first, and then the harness, so that the lap belt is not lifted off the child's lap when the harness is adjusted.
- Use the restraint exactly as shown in the instructions.
- Supervision of children is needed because they may be able to undo the buckles or remove the SecureGuard™ Device.
- Repairs must only be done by the manufacturers or agent.
- Do not allow the restraint to come into contact with polishes, oils, bleach and other chemicals.
- **DO NOT LEAVE CHILDREN UNATTENDED IN THE CAR.**
- Destroy the restraint if it has been in a severe crash, even if no damage is visible.
- **DO NOT USE THIS RESTRAINT WITHOUT THE COVER.**
- Regularly check the restraint components, straps and other fitments for correct function and condition. If faulty, cease using and seek repair by Britax.
- **IF AN AIRBAG IS FITTED IN THE SEATING POSITION WHERE THE CHILD RESTRAINT IS TO BE FITTED, FOLLOW THE VEHICLE MANUFACTURER'S WARNINGS AND INSTRUCTIONS.**
- The child in the seat must not slump or slouch such that the lap belt is on the abdomen. The lap belt on the abdomen is dangerous. The lap belt positioning device SecureGuard™ Device must always be used.
- This child restraint is not approved for use with any connectors that connect to the car's ISOFIX low anchorages.
- Do not alter or modify this restraint.
- Always secure the loose end of the top tether strap. Store in pocket provided.
- **ALWAYS ATTACH HOOK AND REMOVE SLACK. ONLY USE FOR ATTACHMENT OF CHILD HARNESS.**
- **THIS RESTRAINT IS NOT SUITABLE FOR USE WHERE THE TOP TETHER STRAP MAY FALL INTO A SPLIT IN THE SEAT BACK OR OFF THE SIDE OF THE SEAT.**
- Do not lift the seat by the headrest.



CAUTION:

CHILDREN CAN BE INJURED OR RESTRAINTS AND TOP TETHER STRAP DAMAGED BY UNSECURED CARGO IN A COLLISION. SECURE OR REMOVE HAZARDOUS CARGO BEFORE USING THIS CHILD RESTRAINT.



IMPORTANT :

- Protect all webbing from abrasion and cutting by sharp corners and edges.
- This restraint must be used in conjunction with a lap or lap-sash seat belt.
- Seatbelt extenders are not recommended to be used if the seatbelt is not long enough to secure the child restraint. If seatbelts are too short then seek advice from a child restraint fitter and consider their recommendations before using a seatbelt extender. If you use a seatbelt extender then ensure that the seatbelt buckle does not contact the child.
- Do not use in a front seat, unless your child is over 4 years of age or in accordance with the applicable Road Rules in your region. Research shows that children under 12 years old are at a greater risk of serious injury when travelling in the front seat.
- Do not use on any vehicle seat which faces sideways or rearwards.
- Use of aftermarket accessories (i.e. items not provided in the box with the child restraint), can reduce the safety provided by the child restraint and may cause injury or death.
- Use a towel or seat protector (messy mat) to protect the vehicle seat. Protection of both underneath and behind the booster seat may be required.
- Do not store in hot places or underneath heavy objects. The plastic may distort.
- The restraint should not be purchased or sold as a second hand item. It is recommended not to use child restraints older than 10 years as the protection in an accident may be reduced.

SHOULDER HEIGHT MARKERS AND A GROWING CHILD

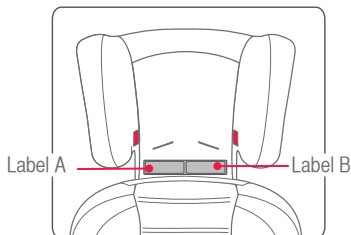

NOTE: Height label will be behind the child's neck.

SMALLER CHILD

Shoulders must not be below the Shoulder Height Marker when the headrest is the lowest position.

From approximately 4 years of age.

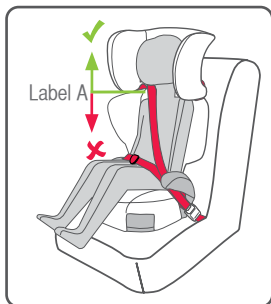

Front of Vehicle

TALLER CHILD

Shoulders must not be above the Shoulder Height Marker when the headrest is in the highest position.

To approximately 6 to 8 years of age.

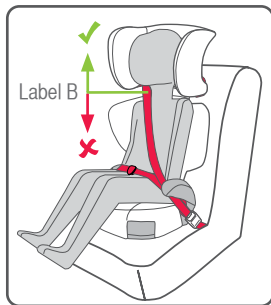

NOTE: These heights also apply if you are using a Child Harness with the booster seat.

SHOULDER HEIGHT MARKERS

! IMPORTANT: Follow this advice.

Label A Smaller Child - Lower Marker

A Child who has outgrown their child restraint with in-built harness will have their shoulders in line or above the lowest shoulder height marker (label A) of this booster seat with the headrest in the lowest position.

If the child's shoulders are below this marker the child needs to stay in their child restraint with an in-built harness.

SHOULDERS ABOVE THIS LINE WHEN



HEADREST AT LOWEST POSITION



Label B Larger Child - Upper Marker

The seat can be used until the child's shoulders reach the Upper Marker (label B) with the headrest fully raised. Usually the shoulders will contact the bottom of the headrest, it is then time to move to the next form of restraint.

For maximum safety continue to use this seat as long as the child fits in the seat.

SHOULDERS BELOW THIS LINE WHEN



HEADREST AT HIGHEST POSITION



Next type of restraint that can be used in the car for your child.

When your child has outgrown the expandable booster seat, you can then use either restraint methods as follows:

A larger booster seat suitable for children up to 8-10 years of age.



Or the car's lap-sash seatbelt if the lower leg is able to hang over the edge of the seat cushion.

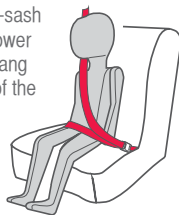

Safe-n-Sound recommend to keep your child in the appropriate restraint suitable for their age and size, only moving to the car's lap-sash seatbelt when he/she no longer fits a dedicated child restraint.



SPECIAL FEATURES

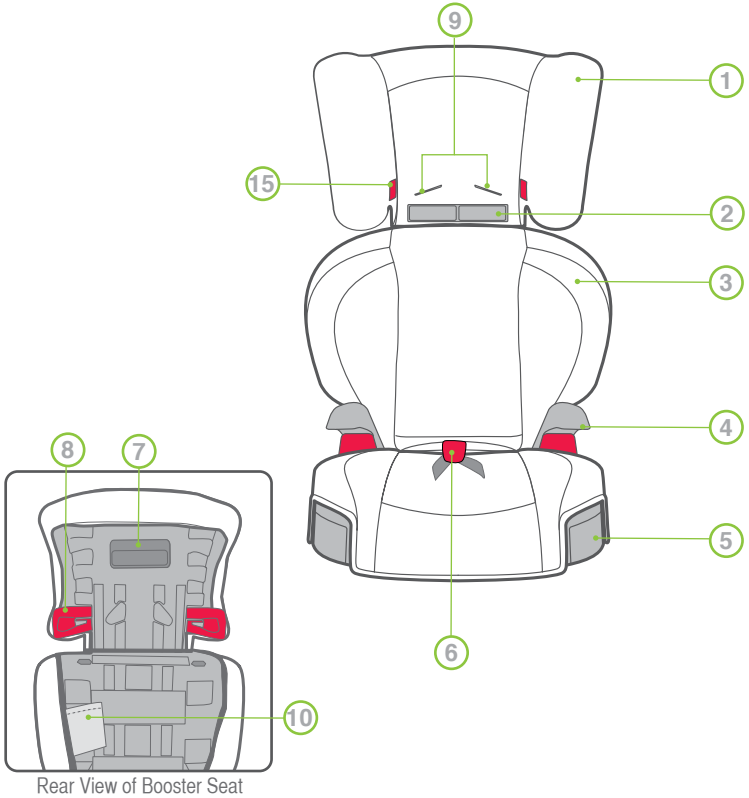

- 1. Adjustable Height Headrest
- 2. Shoulder Height Markers
- 3. Padded Cover for Comfort
- 4. Armrest
- 5. Pull-Out cup holder on each side
- 6. SecureGuard™ Anti Submarining Device
- 7. Headrest Adjustment handle
- 8. Red Sash Guide
- 9. Shoulder slots for use with Child Harness
- 10. Instruction Book pocket

SPECIAL FEATURES

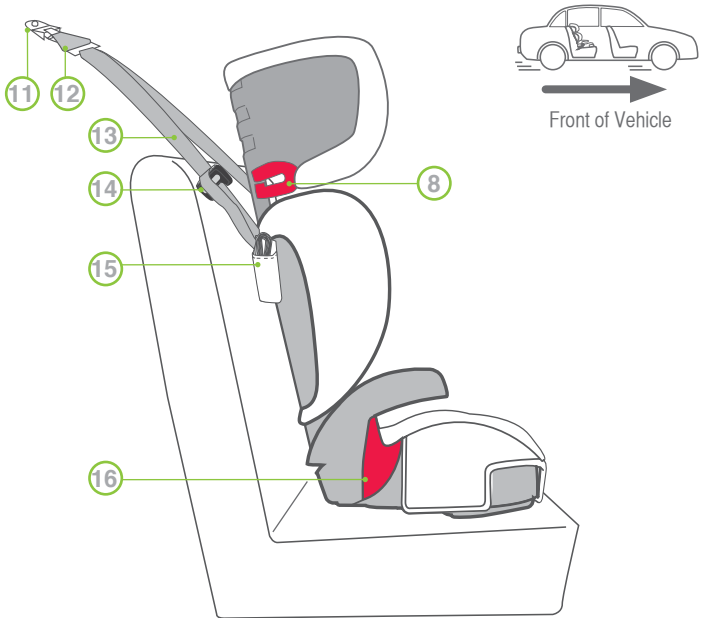

- 11. Car's Upper Anchorage Fitting
- 12. Attachment Clip and **VERSATETHER™**Catch
- 13. Adjustable Top Tether Strap
- 14. Top Tether Strap Adjuster
- 15. Top Tether Storage Pocket
- 16. Booster Seat Belt Path marker

HOW TO SETUP

ADJUSTING THE HEADREST

- A. The headrest can be adjusted to lock into different height locations. This can be done with the child in the seat.
- B. Hold backrest as shown and squeeze the headrest adjustment handle at the back of the headrest with the other hand, to move the headrest up or down.

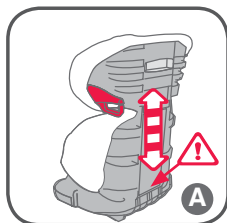

CAUTION:

Keep hands away from gap at the back of the lower backrest whilst adjusting.

- C. Adjust the headrest height so that the bottom of the sash guide is level with or just above your child's shoulder (but not more than 30mm above).

Do not adjust the headrest by pulling on the Side Impact Cushion.

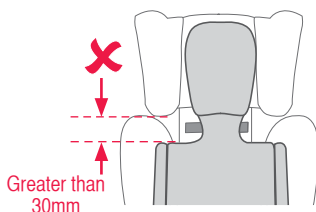
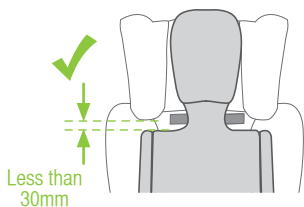
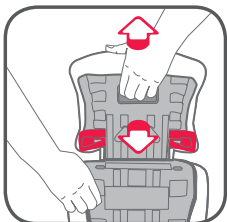

- D. When the headrest is in the correct position let go of the headrest adjustment handle and ensure it has locked into place.

ADJUSTING THE BACKREST

The back rest pivots freely so as to match the car seat back angle. Move the restraint back until it is touching the car's seat back. If the vehicle seat back angle is adjustable put it in the normal upright mode.



Normal backrest angle



Backrest angle too reclined

HOW TO SETUP

ADJUSTING THE SECUREGUARD™ DEVICE

The SecureGuard™ Device crotch strap can be adjusted so that it fits the seatbelt correctly to the child. The crotch strap length adjuster can be found under the seat.

- A. Adjust the crotch straps for the SecureGuard™ Device so that the Lap portion of the seatbelt is positioned on the child's hips and the clip prevents the lap belt rising up the abdomen. Ensure the SecureGuard™ Device does not push into your child's thighs as this may cause discomfort.

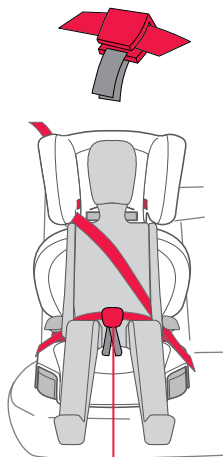

Lower edge of SecureGuard™ Device, level with top of thighs.

CAUTION:
ALWAYS CHECK, ADJUST AND USE THE SECUREGUARD™ DEVICE

- B. Underneath the base the length of the crotch strap can be adjusted by threading webbing through the adjuster in the direction of the arrows shown below.

TO SHORTEN



TO LENGTHEN



SecureGuard™ Device position **TOO HIGH**

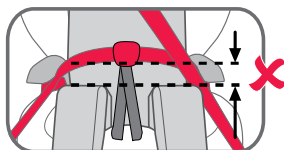

SecureGuard™ Device position **OK**

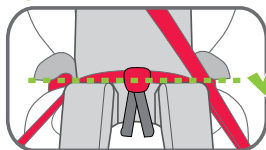

Position lap belt to rest on hips with all slack removed. With SecureGuard™ Device positioned correctly, all slack should be removed from crotch strap.

IMPORTANT :

You must adjust the crotch strap to the correct length for your child before installing the restraint as it cannot be adjusted in the car. Always return the crotch strap to its original shorter length when using the seat with a smaller child. The SecureGuard™ Device must always be positioned low down on your child's body - it will not connect correctly with the seatbelt if it is too high. **DO NOT** attempt to remove or dismantle the crotch strap.

HOW TO INSTALL

INSTALLING INTO VEHICLE

- A. Position the restraint in the car forward facing in the chosen seating position. Adjust the headrest to the correct height for your child (refer to page 16). Use a Messy Mat on seat to protect the car's seat fabric.

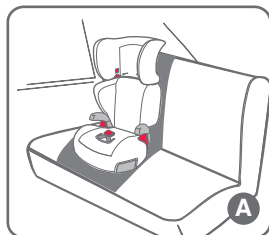

- B. Lengthen the top tether strap and connect the Attachment Clip to the vehicle upper anchorage point making sure to remove as many twists as possible.

To lengthen the top tether strap, fully press Adjuster Button (A) while pulling top tether strap (B) to slacken as shown right.

Ensure the seating position has a child restraint anchorage fitting. Refer to your vehicle owner's manual for the location of the upper anchorage point in the car. If the vehicle is not fitted with a child restraint upper anchorage point then refer to page 41 to 43 for the installation of the upper anchorage point provided with this child restraint.

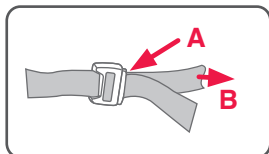
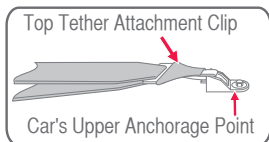

Fully press Adjuster Button (A) while pulling top tether strap (B) to lengthen.



WARNING

Always attach the hook and remove slack

HOW TO INSTALL

- C. Tighten adjustable top tether strap by pulling adjusting strap (C) to remove slack, but do not over-tighten causing the restraint base to lift off the vehicle seat.

Always secure the loose end of the top tether strap to prevent it hanging out of the car or being accessible by the child.

- D. Roll up excess strap and use the storage pocket on the rear of the cover right hand side to neatly store away from child's reach.

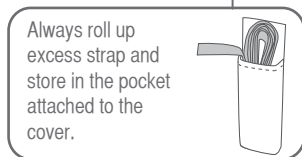
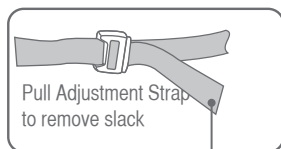
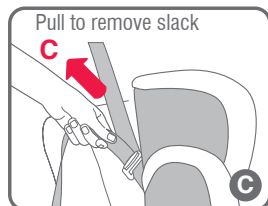

CAUTION:

CHILDREN CAN BE INJURED OR RESTRAINTS AND TOP TETHER STRAP DAMAGED BY UNSECUED CARGO IN A COLLISION. SECURE OR REMOVE HAZARDOUS CARGO BEFORE USING THIS CHILD RESTRAINT.

HOW TO USE

USING LAP-SASH SEAT BELT WITHOUT CHILD HARNESS

- A. Place the restraint Forward Facing in your car, ensuring it is pushed firmly into the car seat and the backrest touches the backrest of the car seat. Sit your child on the seat. Ensure the headrest is set to the correct height for your child (See page 16).

NOTE: In some vehicles, the vehicle headrest may need to be raised or even removed to allow the booster seat to sit correctly, the vehicle headrest may also interfere with the routing of the top tether. If removed, store the vehicle headrest in a safe place. Always replace it when the booster seat is not used in the car.

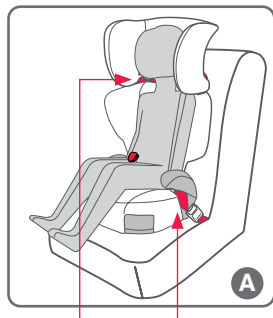

BOOSTER SEATBELT PATH indicator (each side of the seat)

- B. Position the lap-sash belt over the child following the red **BOOSTER SEATBELT PATH** labels, ensuring the lap portion is positioned over the lap belt guides and under the armrests on both sides.

- C. Feed the sash-belt across the child's chest and through the sash guide. The sash guide should be used to correctly position the sash portion of the seatbelt over the child's shoulder and across the chest.

Fit the sash portion of the belt through the sash guide on the headrest as shown.

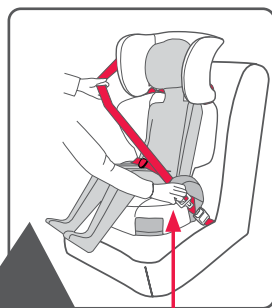

Lap belt and sash under armrest

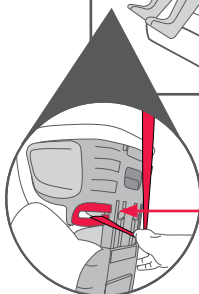

Sash guide

! IMPORTANT: ALWAYS USE THIS SASH GUIDE

HOW TO USE

- D. Engage seat belt buckle and tongue ensuring there are no twists in the belt. If the seat belt buckle is adjustable, adjust the buckle as low as possible away from the child.

NOTE: In some vehicles, the vehicle headrest may need to be raised or even removed to allow the booster seat to sit correctly, the vehicle headrest may also interfere with the routing of the upper anchorage strap. If removed, store the vehicle headrest in a safe place.

- E. Adjust lap and sash portion of seat belt firmly but comfortably across the child's lap and chest.
- F. Adjust and fit the SecureGuard™ Device over the lap part of the seatbelt with the lap belt positioning logo facing forward. The SecureGuard™ Device must be used at all times to prevent the child slumping (sliding forward at base of seat) as the lap belt on the abdomen is dangerous in the event of a crash.
- G. Tighten the lap belt and the sash belt if using an Inertia reel retractor seatbelt, adjust lap portion of the seatbelt firmly around the child and child booster seat, place the sash belt through sash guide where the red **BOOSTER SEATBELT PATH** label is. Allow the slack sash portion retract into the seatbelt.

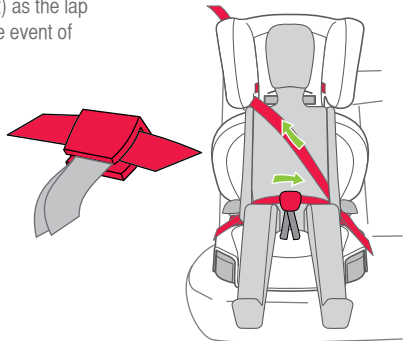
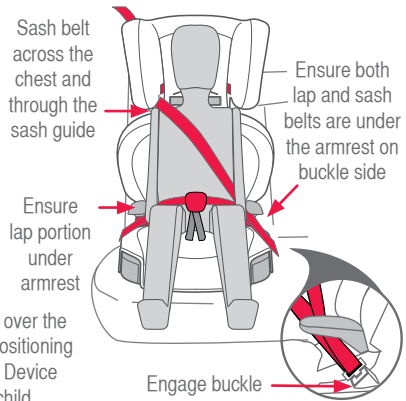

CAUTION:
ALWAYS USE THE SECUREGUARD™ DEVICE



WARNING:

DO NOT LEAVE CHILDREN UNATTENDED IN THE CAR

HOW TO USE



IMPORTANT :

Always ensure the seatbelt is firmly fitted to the hips and thighs and the sash belt is diagonally across the chest.

The SecureGuard™ Device must always be used when the child is using the booster seat as it ensures the lap belt is correctly positioned on the child's thighs and hips. A loose or poorly positioned lap belt can allow the lap belt to ride up into the abdomen and can cause serious injuries in a crash.

Do not place seatbelt sash under the arm or behind the back.



WARNING: A SASH BELT UNDER THE ARM OR BEHIND THE BACK IS DANGEROUS.



SEAT BELT UNDER
THE ARM
IS DANGEROUS

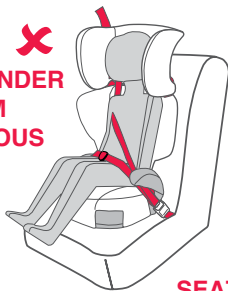

SEAT BELT BEHIND
THE BACK
IS DANGEROUS





HOW TO USE

Adjust headrest so it is close to the shoulders.
Seat belt across the chest and through the sash guides.

Lap belt must always be firm on the thighs.
The child should not slump or slouch.

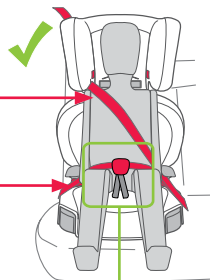

NOTE: Seatbelt extenders should not be used if the seatbelt is not long enough to fit around the child. If a seatbelt extender is used then the seatbelt buckle must not be in contact with the child.

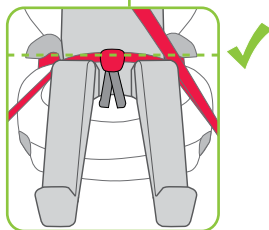

TO REMOVE CHILD

Disengage seat belt tongue and buckle. Remove the lap portion of seat belt from the SecureGuard™ Device, and remove belt from child. When Booster is not being used, secure in position, by engaging seat belt over the booster seat or store in a safe place.

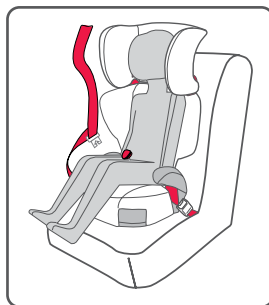

HOW TO INSTALL WITH A CHILD HARNESS

USING WITH A CHILD HARNESS (PURCHASED SEPARATELY)

The Booster Seat can be used with a child harness in a seating position where an upper anchorage fitting is fitted in the vehicle. Refer to the car owners manual for the location of the child restraint upper anchorage fitting and for any precaution related to airbags in selected seating position. If there is no anchor fitting you will need to refer to the instruction book for the child harness which will provide information about fitting an anchor fitting into the car.

This booster seat is only suitable for use with Safe-n-Sound™Protecta PLUS™ Child Harness Series 220/2013. Refer to the instruction book supplied with the Child Harness for full details of using and installing the Child Harness. When installing the Child Harness into a vehicle with a booster seat, connect the top tether to the **VERSATETHER™**Catch on the Booster Seat top tether strap.

If required, use the extension strap supplied with the child harness to attach to an anchor point in the luggage area such as the vehicle floor or roof structures. This extension strap is not suitable for other child restraints.

A child harness **MUST** be used with this Booster seat if the seating position other has a Lap only seat belt.

INSTALLING THE HARNESS

Refer to the child harness instructions.

Decide which seating position you are going to use and note which seat belt type is installed in that position. If using a lap-sash seat belt then a Gated Slide must be used.

- A. Ensure the headrest is set to the correct height for your child (See page 16).
- B. Install the Booster Seat in the vehicle as shown on page 18 -19.

THE STRAP MUST ALWAYS BE FITTED WHEN THE CHILD RESTRAINT IS USED IN A VEHICLE.

Hook attachment clip to the anchor fitting in the Car

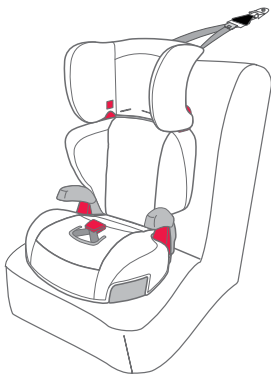



HOW TO INSTALL WITH A CHILD HARNESS

- C. Lengthen the Child Harness using the adjuster under the cover (see the Child Harness instructions). Press the Adjuster button (1) and pull the shoulder strap (2).

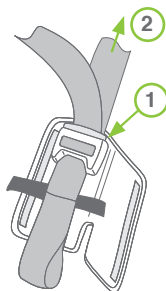
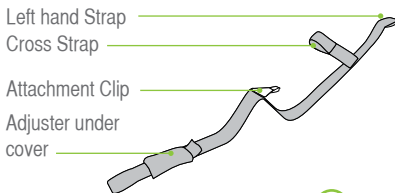

- D. Feed the left hand harness strap and attachment clip through the right hand slot of the booster seat.

Pass the left hand Strap and Attachment Clip through the right hand slot

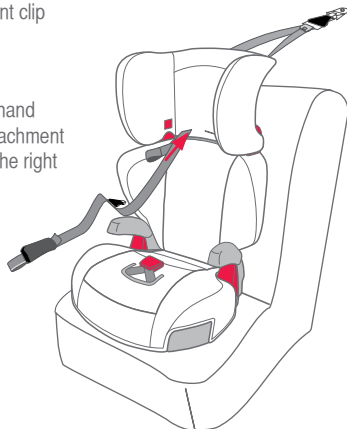



HOW TO INSTALL WITH A CHILD HARNESS

E. Pass the left hand harness strap back through the left hand slot of the booster seat keeping the attachment clip at rear of the booster seat.

F. Hook the Attachment Clip on the Child Harness onto the **VERSATETHER™** Catch of the booster seat using either preferred method shown on page 27 to 28 (with/without extension strap).

Hook the Attachment Clip onto **VERSATETHER™** Catch

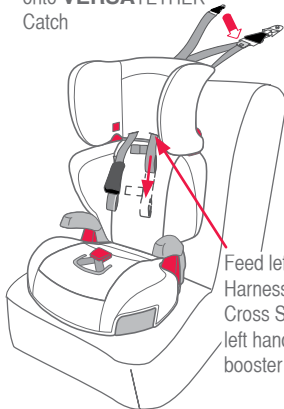

NOTE: The straps must be in the slots provided in the headrest. The shoulder straps must be nearest to the child's shoulder's but not be lower than the child's shoulders.

G. Ensure the two shoulder straps are of equal length (as shown).

Ensure shoulder straps are of equal length.

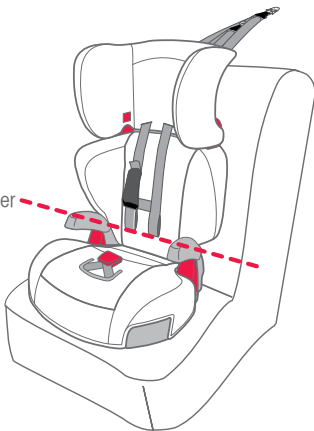

HOW TO INSTALL WITH A CHILD HARNESS

INSTALLING SAFE-N-SOUND PROTECTA PLUS™ CHILD HARNESS INTO VEHICLE WITHOUT EXTENSION STRAP

Hook the Child Harness attachment clip (1) onto booster seat **VERSATETHER™** Catch (2A). Then hook booster seat attachment clip (2B) onto vehicle anchor fitting (3). Ensure that none of the straps are twisted or passing over any sharp edges.

1. Attachment Clip from Child Harness.
- 2A. **VERSATETHER™** Catch.
- 2B. Booster seat Attachment Clip.
3. Anchor Fitting in the car.

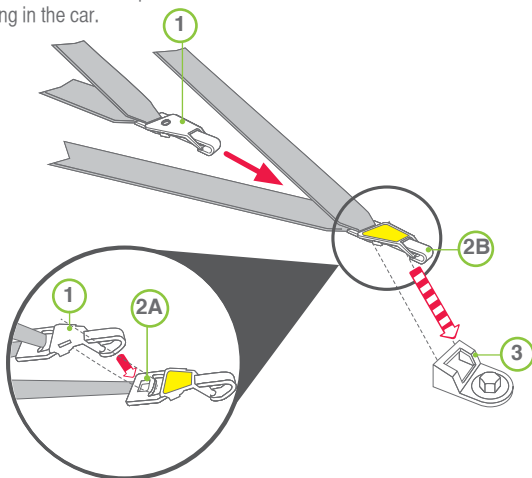

Child Harness Attachment Clip attaches to the **VERSATETHER™**

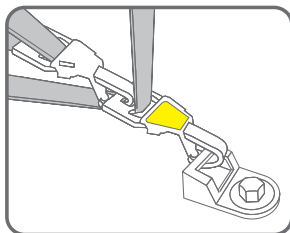



HOW TO INSTALL WITH A CHILD HARNESS

INSTALLING SAFE-N-SOUND PROTECTA PLUS™ HARNESS WITH EXTENSION STRAP INTO VEHICLE

An adjustable extension strap is supplied with the Child Harness. Hook the Safe-n-Sound Protecta PLUS™ Harness clip first onto the extension strap catch, then hook the extension strap clip onto the **VERSATETHER™** Catch on the Booster Seat top tether strap as shown below. Ensure that none of the straps are twisted or catching on sharp edges. Tighten the Booster Seat top tether strap (refer to page 19) then remove excess slack from the extension strap by pulling the adjuster strap as illustrated below.

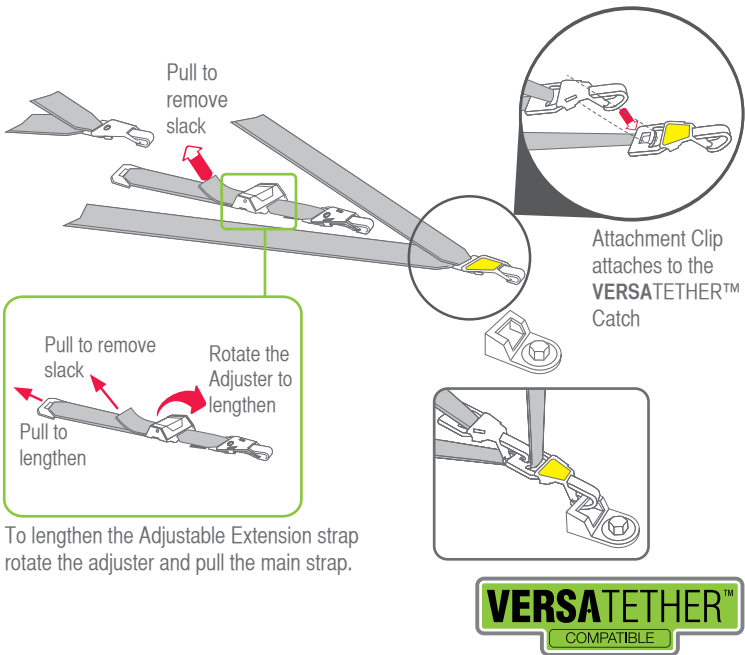

To lengthen the Adjustable Extension strap rotate the adjuster and pull the main strap.



Always attach the hook and remove the slack.



HOW TO INSTALL WITH A CHILD HARNESS

CHOOSING METHOD OF INSTALLATION

A Child Harness can be installed using either of the following methods.

METHOD 1 : Using a lap seatbelt with top tether strap.

METHOD 2 : Using a lap sash seatbelt in conjunction with Gated 3-bar Slide (provided with the Child Harness) to convert to lap belt with top tether strap.

If the seating position has a lap only seat belt then no other preparation is required; go to page 33.

If the seating position has a lap-sash seatbelt then it **MUST** be converted into a lap belt by fitting a Gated 3 bar slide.



CAUTION:

ALWAYS FOLLOW THE CHILD HARNESS INSTRUCTIONS.



IMPORTANT :

The SecureGuard™ Device **MUST ALWAYS** be adjusted and used when the child is using the booster seat with the child harness as it ensures the lap belt is correctly positioned on the child's hips.

A loose or poorly positioned lap belt can allow the lap belt to ride up into the abdomen and can cause serious injuries in a crash.



HOW TO INSTALL WITH A CHILD HARNESS

USING LAP-SASH SEAT BELT WITH THE CHILD HARNESS (Using Gated Slide provided with Child Harness.)

Refer to the Child Harness instructions to fit Gated Slide and adjusting the car seat belt.

Fit the Harness as detailed on page 24-28. Fit Gated Slide to both lap and sash belt as shown on pages 30 & 32. Ensure the Gated Slide is positioned under the armrest and close to the child, but not touching the child. Thread the converted lap-sash seat belt through the harness strap loops as shown left. Ensure there are no twists in the harness, cross strap and seat belt.

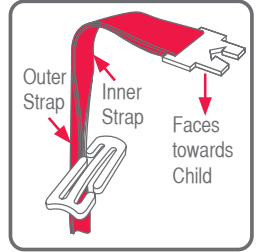

Adjust and fit the SecureGuard™ Device to the lap part of the seat belt with the logo facing forward. The Lap Belt SecureGuard™ Device should be used to reduce the risk of your child submarining (sliding forward on the base of seat).

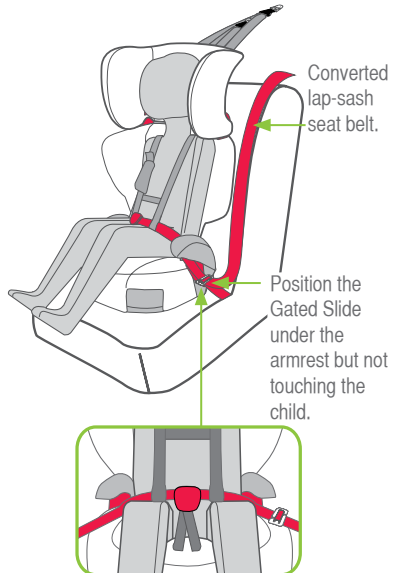

HOW TO INSTALL WITH A CHILD HARNESS

USING THE BOOSTER SEAT WITH A CHILD HARNESS

Only use Gated Slides recommended for this harness.

If using a curved Gated Slide, the belt route through this can only go one way as shown.

Curved

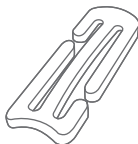

- A. Hold the lap and sash straps together and fold as shown. Slide the inner strap into the Gated Slide followed by the outer strap.



IMPORTANT :

Face the hollow side of the Gated Slide and the inner strap towards the child. Do not use Gated Slide for any other purpose.

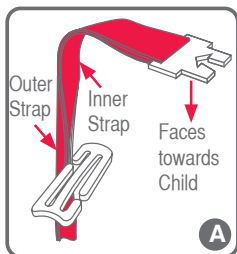

- B. The two straps should slide freely in the Gated Slide slot.

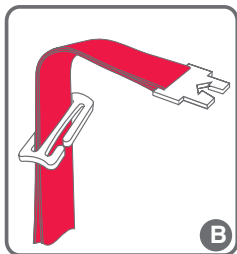

- C. Repeat previous step A for the other slot in the Gated Slide.

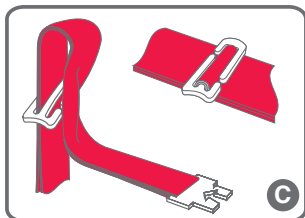

Ensure the lap portion of the seatbelt is nearest to the child

HOW TO INSTALL WITH A CHILD HARNESS

- D. Feed the straps through the Gated Slide to remove any slack. This has now converted the lap-sash seat belt so it will act like a lap only seat belt.

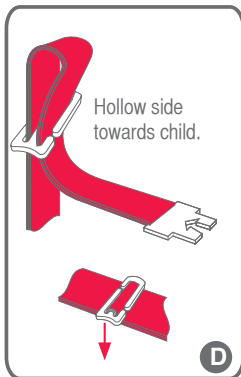
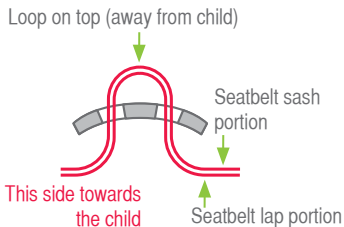

NOTE: TO ENSURE CORRECT CONVERSION OF LAP-SASH SEAT BELT TO LAP SEAT BELT FOLLOW THESE STEPS.



IMPORTANT :

The Gated Slide must be removed from the seat belt if the booster seat and child harness are no longer used in the car so that other users can use the seat belt as a lap-sash seat belt.

A seat belt extender should not be used if the seat belt is not long enough to secure the child. If a seat belt extender is used then the buckle must not be in contact with the child.

HOW TO INSTALL WITH A CHILD HARNESS

USING LAP ONLY SEAT BELT OR CONVERTED LAP-SASH SEATBELT WITH THE CHILD HARNESS

Fit the Child Harness to the booster seat and anchorages as detailed previously. With the vehicle seatbelt converted (if necessary) ready for use, thread the lap seatbelt through the Child Harness strap loops as shown. Ensure there are no twists in the Child Harness, cross strap and seatbelt.

IMPORTANT NOTE: Some vehicle seatbelts are too short and you may experience some difficulty fitting the converted lap-sash around your child. If so, adjust the Gated Slide nearer to your child, ideally into the lap belt recess area, (ensure the Gated Slide does not touch your child). This should provide more belt length to fit your child, but if the belt still will not fit, try another location in the vehicle, e.g. side seat. If the vehicle belts are still too short, then contact the vehicle manufacturer for advice on longer seatbelts.

NOTE: Seatbelt extenders should not be used if the seatbelt is not long enough to fit around the child. If a seatbelt extender is used then the seatbelt buckle must not be in contact with the child.

Connect the Harness to the **VERSATETHER™** Catch as detailed on page 27 to 28.

- With the child seated, place each of the Child Harness straps over each shoulder.
- Feed the right hand strap (loop end) into the cross strap loop to connect the two sides.
- Feed the adult belt (lap belt or converted lap/sash) through the harness loops, ensuring that the cross strap loop does not disconnect. Also ensure there are no twists in the Child Harness, cross strap and seatbelt.

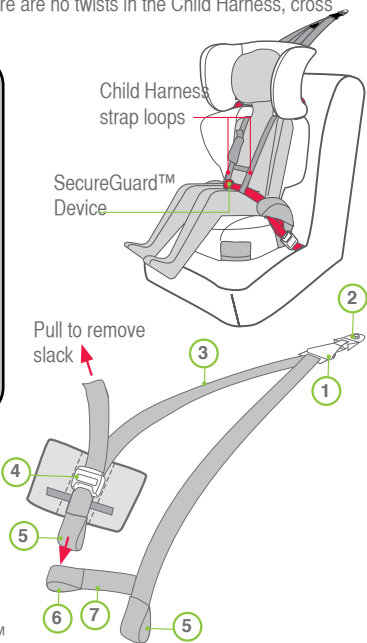

1. Attachment Clip
2. Vehicle Upper Anchorage Fitting
3. Right Hand Harness Straps
4. Adjuster (under cover)
5. Harness Strap Loop
6. Cross Strap Loop
7. Cross Strap

HOW TO INSTALL WITH A CHILD HARNESS

- D. Engage the vehicle seatbelt tongue to the vehicle buckle and adjust the seatbelt to sit firmly but comfortably around the child's pelvis. The seatbelt buckle should be located as low as possible below the child's hip.
- E. With the lap belt (or converted lap/sash) adjusted to be a firm fit on the child's thighs, adjust the Child Harness to remove slack in the shoulder straps. Pull the Adjuster Strap (C) to remove slack. Once adjusted, further adjustments are only necessary to the upper extension strap or to accommodate the growth of the child. Press (A) and pull the shoulder strap (B) to lengthen.

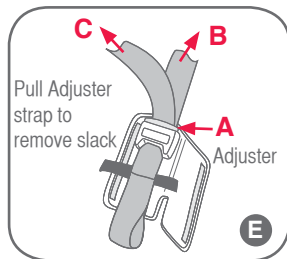

Fully press adjuster button (A) while pulling the Upper Anchorage Strap (B) to lengthen.



CAUTION:

The lap portion of the belt must be adjusted firmly first, and then the harness, so that the belt is not lifted off the child's lap when the harness is adjusted.

- F. Roll up the free end of the adjuster strap, secure using the storage strap, then place it on top of the adjuster cover as shown right and close the cover.
- G. Adjust the SecureGuard™ Device as shown on page 17.
- H. Hook the SecureGuard™ Device over the lap part of the seatbelt with the lap belt positioning logo facing forward. The SecureGuard™ Device must be used at all times to prevent the child slumping (sliding forward at base of seat) as the lap belt on the abdomen is dangerous in the event of a crash.

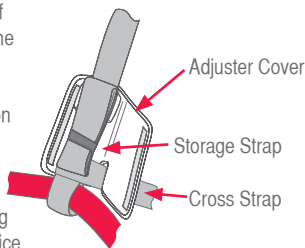

CAUTION:

ALWAYS USE THE SECUREGUARD™ DEVICE

HOW TO INSTALL WITH A CHILD HARNESS



WARNING:

DO NOT LEAVE CHILDREN UNATTENDED IN THE CAR.



IMPORTANT:

Use seatbelt to hold the child restraint when not in use.

TO REMOVE CHILD FROM HARNESS AND SEAT

Disengage seatbelt tongue and buckle, remove the lap portion of seatbelt from the SecureGuard™ Device (where provided) and remove Child Harness and belt from child. When Booster is not being used, secure in position, by engaging seatbelt over the booster seat or store in a safe place.

NOTE: It maybe easier to unthread the car seatbelt out of the loops before lifting the child harness over the child's head.



Lift child harness strap over child's head.

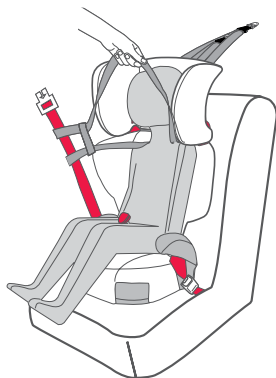

TO REMOVE RESTRAINT FROM VEHICLE

TO REMOVE RESTRAINT FROM VEHICLE

- A. If a Child Harness is used, feed seat belt out through Child Harness.
- B. Disconnect the attachment clip from the car whilst lifting the seat slightly to slacken the top tether strap. This leaves the Child Harness fitted to the booster seat and allows the seat to be put back with no adjustment to the Child Harness if it is in the same vehicle).

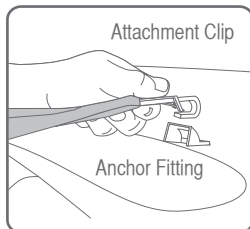

IMPORTANT :

The Gated Slide must be removed from the seatbelt if the booster seat and Child Harness are no longer used in the car to allow other users to use the seatbelt as a lap-sash seatbelt.

CARE & MAINTENANCE

REGULAR CARE OF THIS RESTRAINT:

Please check the following items regularly to ensure the safety of your child:

- A. Check the webbing straps for fraying.
- B. Check there are no cracks in plastic mouldings.
- C. If any part of the restraint is cracked or broken, seek repair immediately contact Britax Customer Service 1300 303 330 or replace the child restraint.
- D. Clean the cover and the seat regularly.

HOW TO CLEAN

HARDWARE: Use only mild soap to clean all metal and plastic parts of your child's restraint, using a damp sponge or cloth. Do not use chemicals or cleaning agents. Do not try and place any hardware into a washing machine.

STRAPS/HARNESS: We recommend spot cleaning straps and harness with a damp sponge or cloth using only cold or warm water. Never place any straps or harness into a washing machine or tumble dryer.

COVER

The booster seat has a cover made from flame retardant fabric and is removable for cleaning. Washing and care instructions are on the care label attached to the cover. Refer to the following pages for instructions on how to remove and replace the cover.



VERY IMPORTANT:

Only replace the cover with BRITAX Safe-n-Sound supplied replacement cover with identical shoulder height markers or a replacement cover meeting AS/NZS 8005.

ONLY USE BRITAX SAFE-N-SOUND SEAT COVERS AND ACCESSORIES THAT ARE DESIGNED AND TESTED FOR USE WITH THIS PRODUCT.

MAINTENANCE

Other than cleaning, there are no parts on this booster seat that require user maintenance.

HOW TO CLEAN

TO REMOVE COVER

- A. To remove main cover, unhook elastics at the rear of the seat and unhook plastic clip from the top sides of the seat.
- B. Where provided, feed the SecureGuard™ Device through the slot in the cover. Unclip the plastic retainers from the front and sides of the seat.
- C. To remove the headrest cover, unhook elastic clips and loops at the rear of the seat.

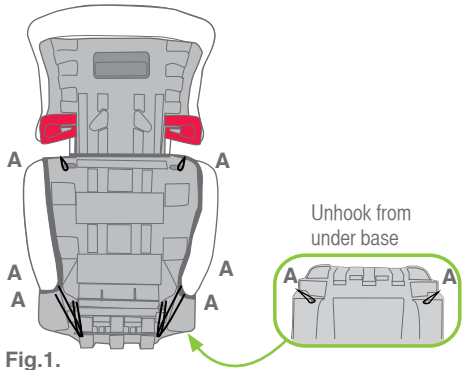
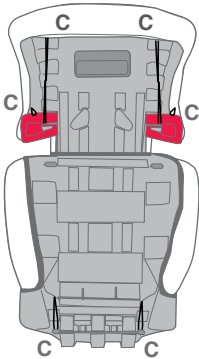
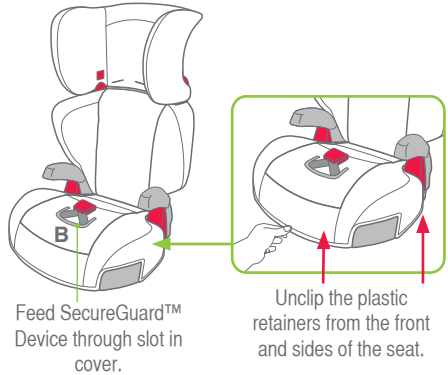

Fig. 1.
Removing Main Cover



Removing Headrest Cover



Feed SecureGuard™ Device through slot in cover.

Unclip the plastic retainers from the front and sides of the seat.



HOW TO CLEAN

TO REPLACE COVER

1. Align and fit headrest cover over seat and re-attach elastic clip and loops at the rear of the seat.
2. Feed SecureGuard™ Device through the cover. Fix plastic retainers to the base at the front and sides of the seat.
3. Align and fit main cover over seat backing. Re-attach elastic loops at the rear of the seat see Fig.1. and hook plastic clip from the top sides of the seat
4. Ensure all loops and retainers are fastened on both left and right sides of seat.



Precautions to prevent reducing the safety offered by this booster seat.

1. Ensure the seat belt is used and fitted correctly. The lap belt must be on the thighs and not the abdomen and the sash belt must be diagonally across the chest and over the shoulder at all times.
2. Ensure the child does not put the sash behind their back or under their arm.
3. Do not use the seat belt in any other way other than following the seat belt path labels.
4. If you are using a child harness, ensure that the lap belt is firm on the child's thighs and not positioned on the abdomen. Do not tighten the Child Harness tether strap, just remove slack so that the lap belt is not lifted.
5. Ensure the child does not slouch or slump. Always use the SecureGuard™ Device to ensure the lap belt is correctly positioned to prevent slumping.
6. Do not cause the seat to be reclined in any way.

ACCESSORIES

Use of aftermarket accessories, (ie; items not provided in the box with the child restraint), can reduce the safety provided by the child restraint and may cause injury or death. Always follow the instructions covering the use of accessories in this booklet or the instructions provided with an accessory. If an aftermarket accessory is used that is not recommended by Britax Safe-n-Sound, ensure that the accessory is compliant with AS/NZS 8005 and is stated as suitable for use with this child restraint. The following instructions apply to accessories that may be supplied with this restraint at point of purchase. If not, a variety of Britax Safe-n-Sound accessories are available from various retailers of Britax Safe-n-Sound products.

MESSY MAT™ (IF SUPPLIED)

Place ribbed or pocket end of the Messy Mat seat protector on edge of car seat, smooth back toward seat join ('A') and fit in any excess Messy Mat into the join of the car seat ('A').



CAUTION:

The pocket is only for small, light items. DO NOT overload the pocket with heavy, bulky items as this may damage the pocket or cause passengers to trip over them.

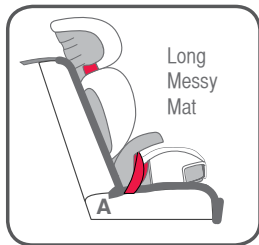

CUP HOLDER (1 EACH SIDE)

To open the cup holder, pull firmly and it will slide out and click into place.



IMPORTANT:

Only use for holding cups, bottles and drink cartons. Do not use for hot drinks. Ensure the cup holder contents cannot be crushed by the car door. Use of the cup holder may limit the seat space next to this restraint.

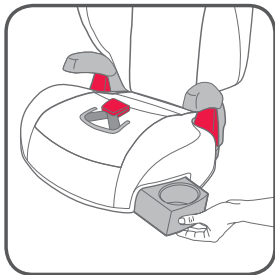

INSTALLATION OF CAR'S UPPER ANCHORAGE POINT

Consult the vehicle owner's handbook for location of anchorage fittings or anchorage points and the possible use of spacers. Some vehicles may have an anchor fitting fitted by the vehicle manufacturer. If anchorage points cannot be found refer to car manufacturer or local child restraint fitting station or traffic authority for optimum position of upper anchorage point and the use of spacers.

UPPER ANCHORAGE STRAP



IMPORTANT:

THE ATTACHMENT CLIP COVER MUST ALWAYS BE USED AS IT PREVENTS THE RISK OF INCORRECT FITMENT OF THE ATTACHMENT CLIP TO THE UPPER ANCHORAGE POINT. ALWAYS ENSURE THAT THE ATTACHMENT CLIP IS CORRECTLY ENGAGED TO THE UPPER ANCHORAGE POINT AND NOT HOOKED OR FITTED TO ANY OTHER OBJECT BEFORE EACH USE OF THE RESTRAINT. THIS IS ESPECIALLY IMPORTANT IN VEHICLES SUCH AS STATION WAGONS, VANS, HATCH BACKS OR VEHICLES WITHOUT A FIXED PARCEL SHELF, SINCE THE ANCHOR POINT IS USUALLY NOT VISIBLE.

Extension Straps

Length 300mm (Use Britax Safe-n-Sound part 0035 or 0291).

Length 600mm (Use Britax Safe-n-Sound part 0036 or 0290).

Available from all major child restraint retailers.

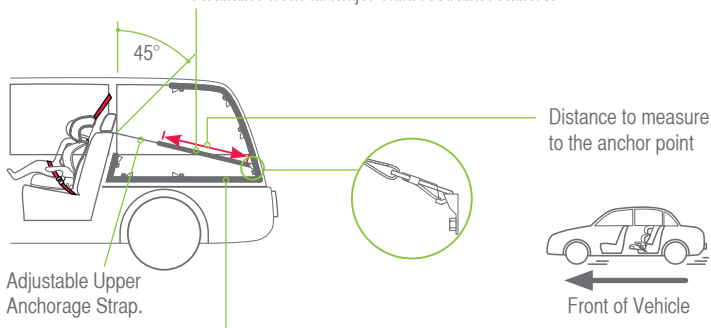

The shaded areas of this diagram illustrate the possible locations of the upper anchorage point. Within each shaded area is an upper anchorage point showing the correct way to install the fitting. Ensure the upper anchorage point is aligned as illustrated unless stated otherwise in the vehicle owner's handbook.

INSTALLATION OF CAR'S UPPER ANCHORAGE POINT

IF THE CAR IS FITTED WITH CHILD RESTRAINT UPPER ANCHORAGE POINT

Locate the upper anchorage point behind the rear seating position. (Consult the car owners handbook for the location of the upper anchorage point). The upper anchorage point should be directly behind and central to the restraint. Remove thread plug from the parcel shelf/floor/roof, etc. and install attachment bolt and fitting as shown in Fig 1.

CAUTION: DO NOT OVERTIGHTEN ATTACHMENT BOLT. OVERTIGHTENING MAY FRACTURE OR BREAK BOLT. MAXIMUM TORQUE IS 20 Nm(14.75 ft.lb.)

Note: Minimum of five full turns of attachment bolt is required before tightening force is applied.

IF THE CAR IS NOT FITTED WITH CHILD RESTRAINT UPPER ANCHORAGE POINTS

For Sedans only - Drill 9mm diameter hole in the parcel shelf on the centre line of the seating position as shown in Fig 3. Before drilling the hole, check the underside for accessibility. Install the attachment bolt as shown in Fig 2. It is recommended that this installation be carried out by a child restraint fitting station or licenced motor mechanic.

For vehicles other than Sedans - In Australia, consult your nearest child restraint fitting station or traffic authority for vehicle inspection to find the best, correct position for the placement of the upper anchorage point, and for the correct attachment bolt length and use of spacers. In New Zealand, consult the agent for the vehicle. Note to Queensland purchasers: The installation of anchorage points must be approved by authorised officers appointed by Queensland Transport. Authorised officers can be sourced from all Queensland Transport Customer Service and Kidsafe Queensland.

UPPER ANCHORAGE FITTING

Fig.1.

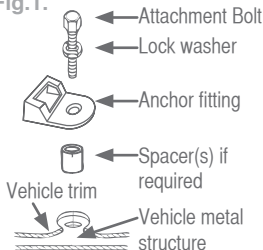

UPPER ANCHORAGE FITTINGS FOR SEDANS ONLY

Fig.2.

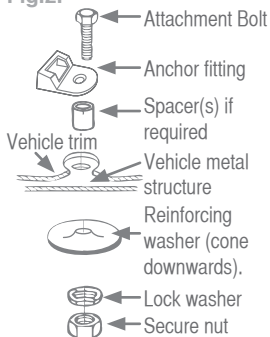

INSTALLATION OF CAR'S UPPER ANCHORAGE POINT

ONLY USE A 5/16 UNC GRADE 5 BOLT. IF THE BOLT IS NOT THE CORRECT LENGTH THE CAR MANUFACTURER'S HAND BOOK CAN PROVIDE ADVICE ON THE CORRECT LENGTH BOLT.



NOTE: Marking on the top of a Grade 5 Bolt. Do not use any bolt without these marks.



WARNING

CHILD RESTRAINTS MUST NOT BE ATTACHED TO UNSOUND METAL OR TO WOOD, OR SYNTHETIC STRUCTURES. WHEN DRILLING 9 MM HOLE DO NOT DRILL THROUGH FUEL LINES, FUEL TANKS, ELECTRICAL WIRING, OR RADIO SPEAKERS.

WEBBING STRAPS MUST BE PROTECTED FROM SHARP CORNERS AND EDGES. THE ANCHOR FITTING MUST BE USED ONLY AS DESCRIBED ABOVE. IT MUST NOT BE HOOKED ONTO ANY OTHER OBJECT.

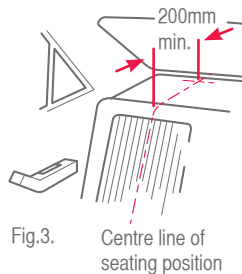

CAR INSTALLATION ACCESSORIES (From retailers of Britax Safe-n-Sound products)

EXTRA ANCHOR KITS: Available for using the restraint in additional cars.
Re-order no: 0038 or 0289

TOP TETHER EXTENSION STRAPS: May be required for cars without a fixed parcel shelf.
Re-order no: 0035 or 0291 (length 300mm) or
0036 or 0290 (length 600mm)

IN CASE OF CRASH

If your restraint has been involved in a severe crash, you should destroy the restraint even if no damage is obvious. Some insurance companies offer vehicle insurance which covers or partially covers the replacement of your child restraint. Contact your insurance company for further details. Your insurance company may require you to keep the child restraint for assessment, **but do not use the child restraint after a severe crash**. To assist you in making an accident insurance claim cut the following statement and include it with your claim.

NOTICE TO INSURANCE COMPANY CHILD RESTRAINT INVOLVED IN AN ACCIDENT

This Britax Safe-n-Sound child restraint is manufactured to Australian/New Zealand Standard AS/NZS1754-2013 which requires us to advise users of child restraints to "Destroy the entire restraint if it has been in use in a severe crash, even if no damage is obvious". The joint Australian/New Zealand Standards committee CS/085 advise that this statement applies whether a child was in the child restraint or not. A severe crash, we consider as being one where the main body structure of the vehicle is distorted.

There is no method of determining if the restraint has been damaged and we concur with the Australian/New Zealand Standards in recommending destruction of the child restraint.

This notice is to advise you of the requirements of the Australian/New Zealand Standards and our obligation in complying with the standards.

Please assist the owner of this restraint in their claim.

AUSTRALIA

Britax Childcare Pty. Ltd.
A.B.N 55 006 773 600
Head office and registered address
Level 4, 650 Lorimer Street,
Port Melbourne, VIC 3207
P.O. Box 5119 Garden City, VIC, 3207
Customer Service 1300 303 330
Email au-custserv@britax.com
www.britax.com.au

NEW ZEALAND

Britax Childcare (NZ) Ltd.
Customer Service 0508 688 822
Email nz-custserv@britax.com
www.britax.co.nz



IN CASE OF CRASH

CRASH EXCHANGE

We would never want you to experience an accident, but unfortunately accidents do happen. If you experience an accident you may be eligible for a free replacement.

The Safe-n-Sound Crash Exchange Program is a voluntary program designed to ensure that our children are safe and that any seat that may have experienced a severe crash is taken out of the market.

There is no method of determining if the restraint has been damaged in a severe crash, so the restraint should be destroyed as the crash may reduce the child restraints ability to perform.

Since its inception in 2006, the Crash Exchange program has helped 100's of families ensure that their children have new restraints and that the restraints are not sold second hand placing others at risk.

Our Crash Exchange Terms and Application form are accessible on our website. Please visit www.britax.com.au for further information.





NOTES



AUSTRALIA

Britax Childcare Pty. Ltd.
A.B.N 55 006 773 600

Head office and registered address:

Level 4, 650 Lorimer Street, Port Melbourne, VIC, 3207
P.O. Box 5119 Garden City, VIC, 3207

Customer Service 1300 303 330

Email au-custserv@britax.com

www.britax.com.au

NEW ZEALAND

Britax Childcare (NZ) Ltd.

Customer Service 0508 688 822

Email nz-custserv@britax.com

www.britax.com.nz

INTERNATIONAL ENQUIRIES

Contact your local Distributor



HI-GROW™

Scan QR code for features, how to use and installation.



HI-LINER SG™

Scan QR code for features, how to use and installation.

britax
safe·n·sound

WARRANTY

Our goods come with guarantees that cannot be excluded under the Australian Consumer Law. You are entitled to a replacement or refund for a major failure and compensation for any other reasonable foreseeable loss or damage. You are also entitled to have the goods repaired or replaced if the goods fail to be acceptable quality and the failure does not amount to a major failure.

For the full terms of the Warranty refer to the Britax website www.britax.com.au/service-support/warranty

The Safe-n-Sound, SecureGuard and Protecta PLUS trademarks are the property of Britax Childcare Pty, Ltd. (Australia).

The BRITAX and Safe-n-Sound trademarks are the property of Britax Childcare Holdings Ltd, UK.

We reserve the right to alter this product without notice.

© 2002-2018 Britax Childcare Pty, Ltd. Patents apply.

39