



Baby Capsule

CLICKTIGHT compatible

0_{YRS}

12_{MTHS}

IMPORTANT:
KEEP THIS BOOKLET IN
THE PLACE PROVIDED ON
THE CHILD RESTRAINT

Contents

Setup

QUICK SETUP GUIDE	04
• REARWARD FACING SEATBELT	04
MEET YOUR CHILD SEAT	10
IMPORTANT INFORMATION AND WARNINGS	12
SHOULDER HEIGHT MARKERS	14
OUTGROWN YOUR CHILD SEAT	16
CHILD SEAT SUITABILITY GUIDE	17

Rearward Facing

CHILD SEAT FEATURES – REARWARD FACING SETUP	18
• GENERAL INFORMATION	21
• ADJUSTING THE BASE ANGLE	22
• INSTALLING INTO YOUR VEHICLE	24
• TOP TETHER	27
• ADJUSTING HANDLE POSITION	30
• HARNESS FEATURES	31
• CROTCH STRAP	32
• LAP STRAP	33
• SETTING UP THE HARNESS	34
REMOVE CHILD FROM CAPSULE	41
REMOVE CAPSULE FROM VEHICLE	42
REMOVE BASE FROM VEHICLE	43



REARWARD FACING
INSTALLATION VIDEO
SERIES NO.
BS2300A-C20135



REARWARD FACING
INSTALLATION VIDEO
SERIES NO.
BS2300B-C20135

Aircraft

HOW TO INSTALL IN AN AIRCRAFT	44
--------------------------------------	----

Care & Maintenance

BRITAX STROLLERS	47
CARE AND MAINTENANCE	48
• CLEAN HARNESS BUCKLE	49
• REMOVE COVER	51
• REPLACE COVER	54
ACCESSORIES	57
INSTALLATION OF VEHICLE UPPER ANCHOR POINT	62
IN CASE OF ACCIDENT	68
WARRANTY	72

4 Hey! before you install me...

Note your serial number to complete warranty registration.

For Series No. BS2300A–C20135:
Your seat has 4 harness slots. Your seat is certified for low birthweight infant compatibility.

For Series No. BS2300B–C20135:
your seat has 3 harness slots.

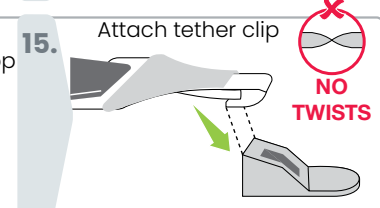
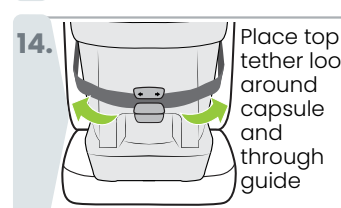
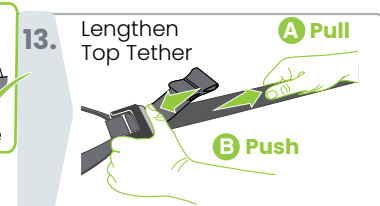
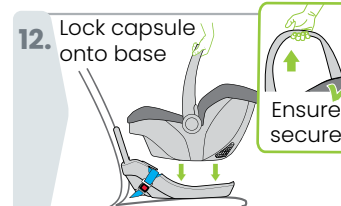
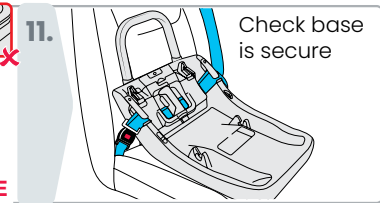
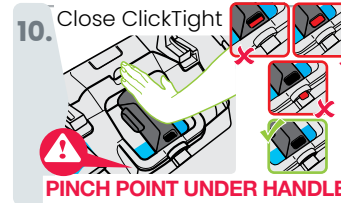
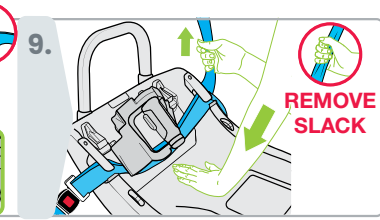
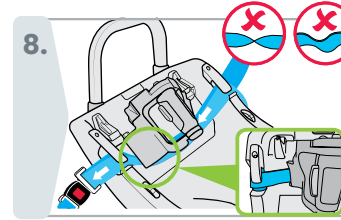
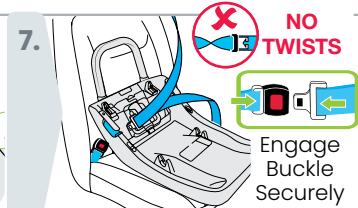
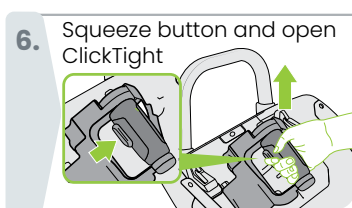
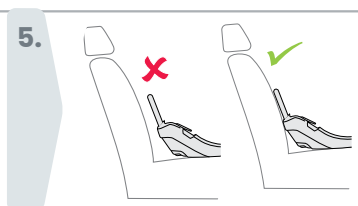
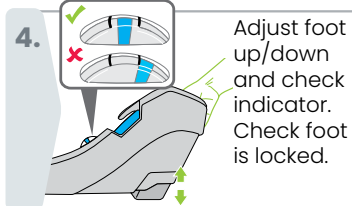
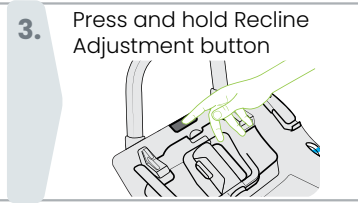

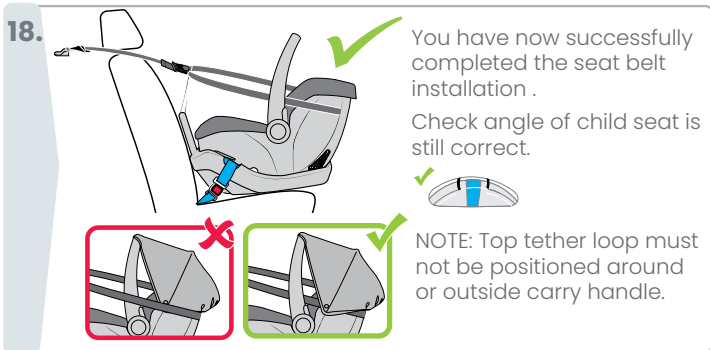
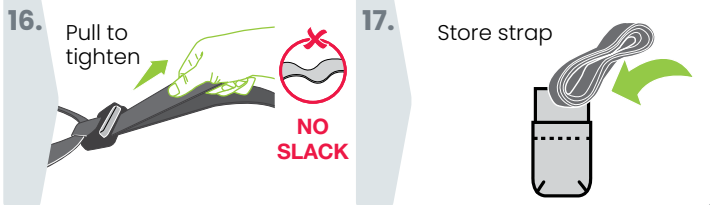

Harness Slot Positions On Your Baby Capsule



BS2300A-C20135 – Your seat has 4 harness slots. Your seat is certified for low birthweight infant compatibility.

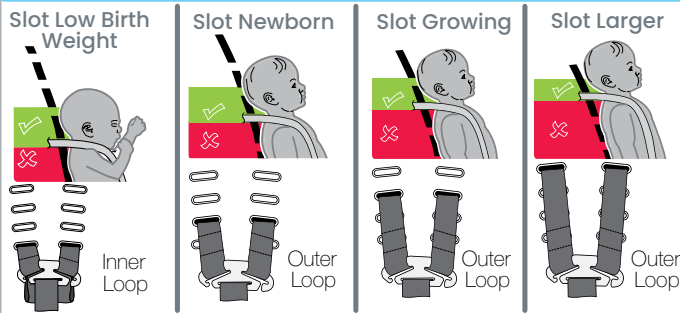

BS2300B-C20135 – Your seat has 3 harness slots.

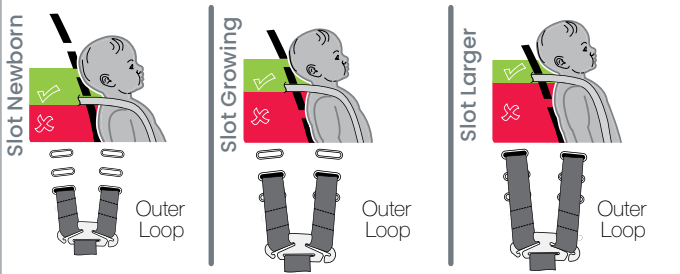

HARNES STRAPS NOT BELOW GREEN ZONE

1. **A Press** **B Pull** **C Press**

2. Remove straps from yoke

3. Pull through cover

4. Choose correct slot

5. **NO TWISTS**
Replace straps to yoke

6. Buckle Tongue holders (if fitted)

7. Crotch Strap Options

8. Lap Strap Options - Series BS2300A-C20135 Only

AVERAGE NEWBORN INFANT LAP

LOW BIRTH WEIGHT LAP

9. Lock capsule onto base

Ensure secure

10. Install child & check shoulder height.

11. Lengthen Top Tether

12. Lengthen Top Tether

A Pull **B Push**

13. Place top tether loop around capsule and through guide

14. Attach tether clip

NO TWISTS

15. Pull to tighten

NO SLACK

16. Store strap

REMOVE SLACK AND TWISTS FROM HARNESS AND TOP TETHER.

Check your barcode and make note of the Series Number.

FOR SERIES NO. BS2300A-C20135: Your seat has 4 harness slots. Your seat is certified for low birthweight infant compatibility.

Suitable for low birth weight and premature infants without restrictive medical conditions. To be used only in a rearward-facing position until the infant's shoulders reach the shoulder height marker (approximately 12 months of age). Continue to use this infant restraint until the child reaches this limit. Infants are at risk of serious injury if they face forward too early.

适用于没有严格医疗条件的低出生体重婴儿和早产儿。只采用后向式安装，直到婴儿的肩膀达到肩高标记（大约12个月的宝宝）在儿童达到该座椅上限以前必须不断使用这一婴儿汽车座椅。婴儿过早乘坐前向式座椅则可能受到严重的伤害。

Phù hợp với bé sơ sinh nhẹ cân và bé sanh thiếu tháng không có tình trạng sức khỏe giới hạn. Chỉ được sử dụng ở vị trí hướng mặt về phía sau cho đến khi vai của bé cao tới vạch ghi độ cao của vai (khoảng 12 tháng tuổi). Hãy tiếp tục sử dụng ghế em bé này cho đến khi em cao tới giới hạn này. Bé sơ sinh có nguy cơ bị chấn thương nghiêm trọng nếu hướng mặt về phía trước quá sớm.

FOR SERIES NO. BS2300B-C20135 : Your seat has 3 harness slots.

To be used only in a rearward-facing position until the infant's shoulders reach the shoulder height marker (approximately 12 months of age). Continue to use this infant restraint until the child reaches this limit. Infants are at risk of serious injury if they face forward too early.

只采用后向式安装，直到婴儿的肩膀达到肩高标记（大约12个月的宝宝）在儿童达到该座椅上限以前必须不断使用这一婴儿汽车座椅。婴儿过早乘坐前向式座椅则可能受到严重的伤害。

Chỉ được sử dụng ở vị trí hướng mặt về phía sau cho đến khi vai em bé cao tới vạch ghi độ cao của vai (khoảng 12 tháng tuổi). Hãy tiếp tục sử dụng ghế em bé này cho đến khi em cao tới giới hạn này. Bé sơ sinh có nguy cơ bị chấn thương nghiêm trọng nếu hướng mặt về phía trước quá sớm.

No child restraint can guarantee absolute protection from injury in every crash. However, to ensure that your child gets all the protection designed into the restraint, PLEASE READ AND FOLLOW THESE INSTRUCTIONS EXACTLY and use only Britax Safe-n-Sound recommended parts and accessories. Carefully read all the instructions for installation in this book. If in doubt about the method of installation, consult Britax childcare agent or a child restraint fitter or, in New Zealand, to consult the agent for the vehicle.

The baby capsule and base is installed so that the infant is facing rearwards.

Babies and children below 4 years old must not sit in the front seat of a vehicle unless allowable by the Regional Road Rules

Check your local Regional Road Rules.

Always store the instruction book in the place provided in the base when the baby capsule is removed.

This baby capsule is compatible with various Steelcraft, Safe-n-Sound and competitor strollers. For detailed compatibility refer to www.britax.com.au.

Britax Childcare Pty Ltd continues to provide care for your children when traveling in motor cars with a range of child restraints suitable throughout their childhood.

WARNINGS

- Use the restraint exactly as shown in the instructions.
- Supervision of children is needed because they may be able to undo the buckles and adjusters.
- DO NOT LEAVE CHILDREN UNATTENDED IN THE CAR.
- Do not alter or modify this restraint.
- Repairs must only be done by the manufacturers or agent.
- Fit the restraint firmly to the car seat.
- Fit the harness firmly to the child.
- A loose restraint or harness is dangerous.
- DO NOT USE A REAR-FACING CHILD RESTRAINT WHERE AN AIRBAG IS FITTED IN FRONT OF THE SEATING POSITION. For other airbags, refer to the car owner's handbook for warnings and instructions.
- To ensure infant's back is evenly supported do not put more than one nappy on the baby and make sure the nappy is not thickly folded at the back.
- Do not allow the restraint to come into contact with polishes, oils, bleach and other chemicals.
- Destroy the restraint if it has been in a severe crash, even if no damage is visible.
- Do not harness an infant wrapped in a blanket or swaddled. Any blanket or wrap must only be placed over the harness and infant.
- Always secure the loose end of the top tether strap. Do not use the child restraint where this strap may fall into the seat back or off the side of the seat.
- ALWAYS ATTACH HOOK AND REMOVE SLACK.
- DO NOT USE THIS RESTRAINT WITHOUT THE COVER.

IMPORTANT :

- TO BE USED WITH A LAP-SASH OR LAP-ONLY SEATBELT IN THE BACK OF MOST CARS WITH FORWARD FACING SEATS
- THIS RESTRAINT MUST BE ATTACHED TO A CHILD RESTRAINT UPPER ANCHORAGE POINT IN THE CAR. REFER TO CAR OWNER'S HANDBOOK FOR LOCATION OF UPPER ANCHORAGE POINTS. REFER TO A CHILD RESTRAINT FITTING STATION IF NO UPPER ANCHORAGE POINTS ARE IN THE MOTOR CAR.
- THIS RESTRAINT IS NOT SUITABLE FOR USE WHERE THE TOP TETHER STRAP MAY FALL INTO A SPLIT IN THE SEAT BACK OR OFF THE SIDE OF THE SEAT.
- **Always attach the top tether strap to the child restraint and upper anchorage in your car before each journey.**
- This child restraint is not approved for use with any connectors that connect to the car's ISOFIX low anchorages.
- Seatbelt extenders are not recommended to be used if the seatbelt is not long enough to secure the child restraint. If seatbelts are too short then seek advice from a child restraint fitter and consider their recommendations before using a seatbelt extender, ensure that the seatbelt or extender buckle does not enter the seatbelt path or prevent the capsule locking onto the base.
- Ensure babies and toddlers are adequately shaded from direct sunlight through side and rear windows.
- Check the car is ventilated by opening windows or using the car ventilation system to introduce fresh air. The recirculation setting is not suitable to provide ventilation.
- The restraint should not be purchased or sold as a second hand item. It is recommended not to use child restraints older than 10 years as the protection in an accident may be reduced.

14 Shoulder Height Markers

A Shoulder Height Marker is featured on this baby capsule. This is an indicator for when your infant has outgrown the seat and it should be superseded.

Height Marker

If your child's shoulders are above the height marker, they have outgrown the seat.

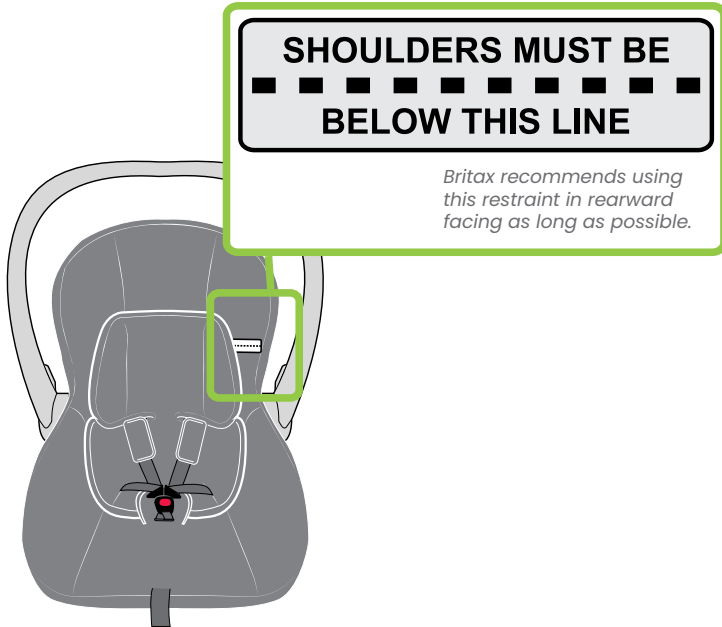

Shoulder Height Markers 15

 **IMPORTANT:** Follow this advice.

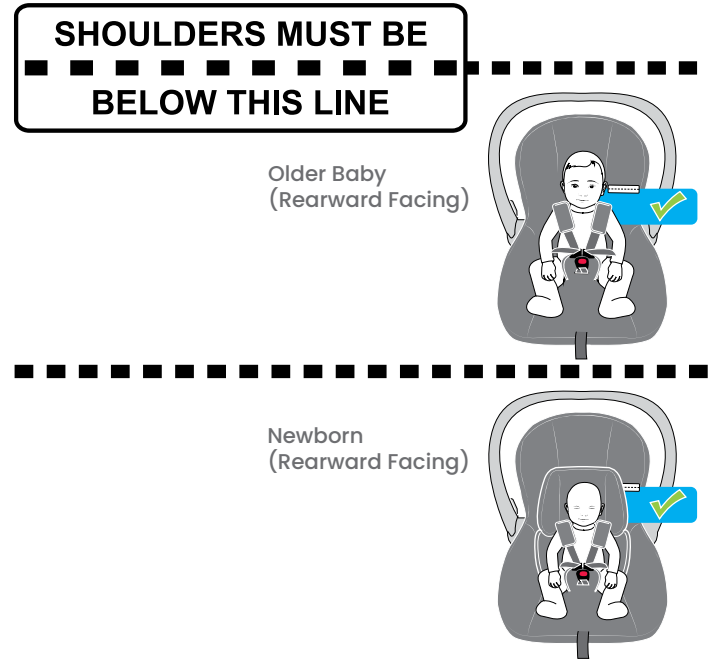

16 Outgrown Your Child Seat

When your child has outgrown this seat, you can use:



- Convertible Child Seat: **Suitable from approximately 12 months**, continue to keep your child rear facing until the shoulders reach the lower shoulder height marker. Then turn to forward facing until the child reaches the upper shoulder height marker – **approximately 4 years of age**.

Some convertible child seats may allow for the child to remain rearward facing until 2 to 3 years of age.



- Dedicated Forward Facing Seat with in-built harness: Suitable for children who have outgrown their Baby Capsule (from approximately 6 months old), up to **approximately 4 years of age, or 8 years of age** depending on the restraint.

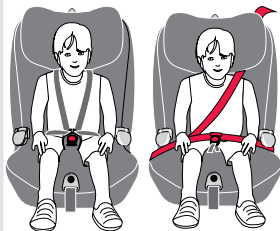

- A convertible booster seat with in-built harness until **approximately 4 years old** and then as a booster seat with vehicle lap-sash seatbelt until **approx 6 to 8 years of age** (or seatbelt and compatible child harness).

Child Seat Suitability Guide 17

These child restraints, when used correctly, allow the driver to meet the Australian Road Rules in each state.

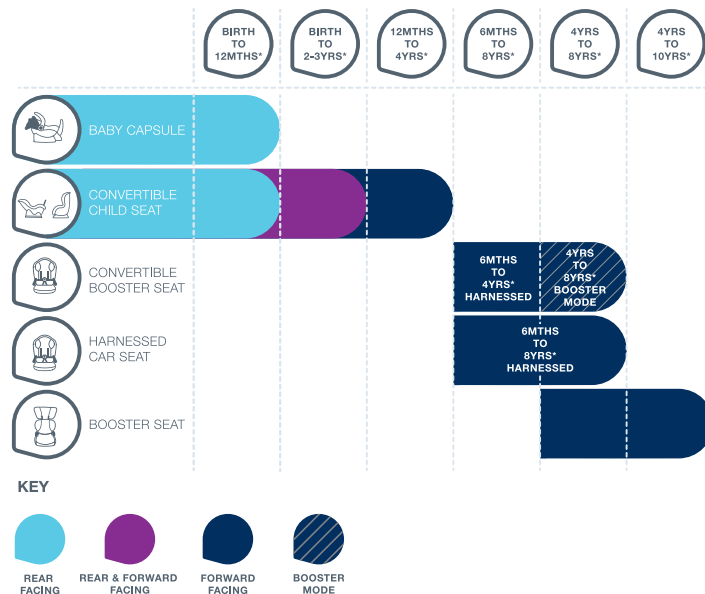

* Ages are an approximation. Refer to the shoulder height markers for progression to forward facing mode or graduation to next restraint.

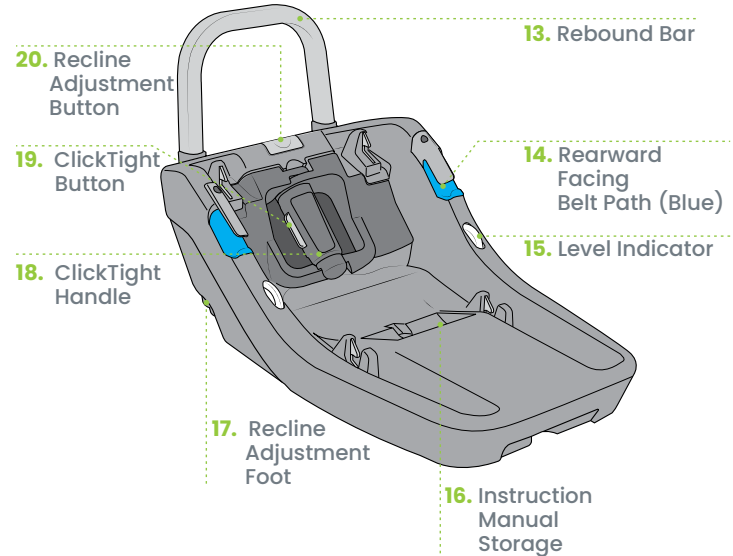
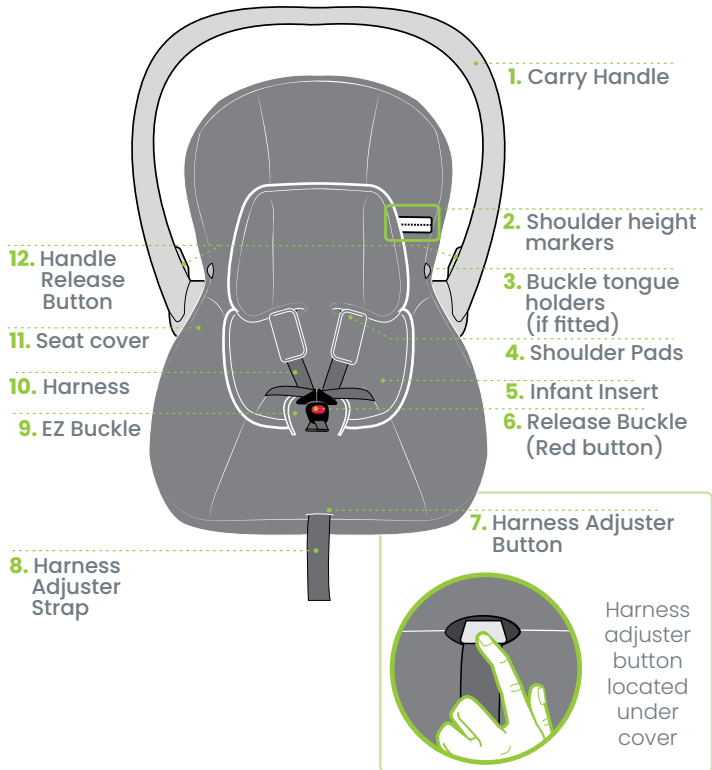



Front of vehicle

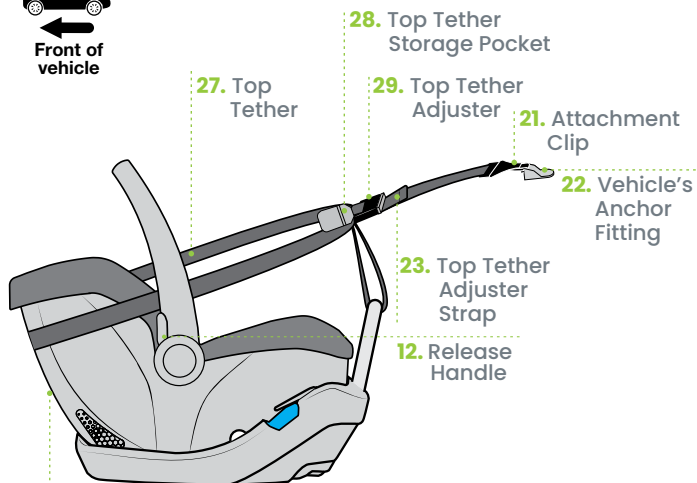

27. Top Tether

28. Top Tether Storage Pocket

29. Top Tether Adjuster

21. Attachment Clip

22. Vehicle's Anchor Fitting

23. Top Tether Adjuster Strap

12. Release Handle



24. Top Tether Guides

25. Capsule Release Lever (from Base or Stroller)

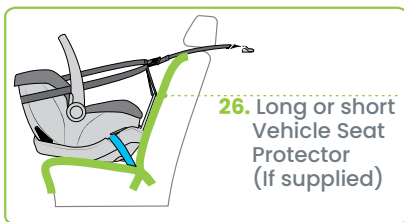

26. Long or short Vehicle Seat Protector (if supplied)

Child seat upper anchorage point

This child seat must be installed using the top tether. The top tether will need to attach to the appropriate upper anchorage point for rearward facing mode. Refer to the car owner's handbook for anchorage locations or points. If your vehicle does not have an upper anchorage point then you will need to install an upper anchorage point. Refer to pages 58 to 63.

Is there enough room?

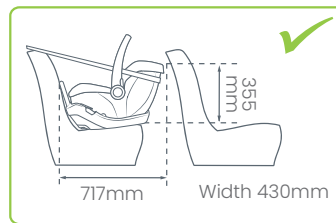

To ensure that the space is sufficient, the purchaser should check the measurements between the vehicle's rear and front seats in which the child restraint is intended to be used.

⚠ WARNINGS



THE TETHER STRAP MUST ALWAYS BE FITTED WHEN THE CHILD RESTRAINT IS USED IN A VEHICLE.

Do not use the restraint without the top tether strap correctly attached. DO NOT USE A REAR FACING CHILD RESTRAINT WHERE AN AIRBAG IS FITTED IN FRONT OF THE SEATING POSITION. Do not use on any vehicle seat which faces sideways or rearwards.

The Baby Capsule may just touch the front seat, but must not in such a way that the installation angle is affected. Do not allow the front seat to alter the installed angle of the restraint.

22 Setup - Adjusting the Base Angle

The Level Indicator shows when your child seat is installed at the correct angle for your vehicle. It gives you confidence the child seat is positioned correctly whenever you travel.

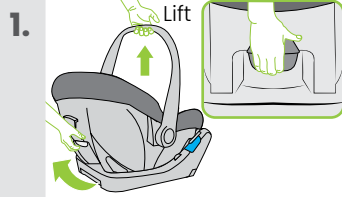

Pull up and hold the release lever on the back of the capsule. Lift the capsule up from the base using the carry handle.

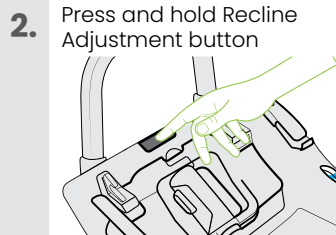

Place the base on vehicle seat in a seating position where a child restraint anchor fitting is installed.

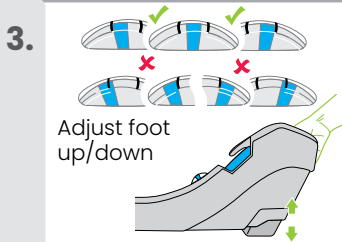

Adjust the base until the entire blue marker is completely visible between the two lines while on the vehicle seat. Check and adjust the base if necessary.

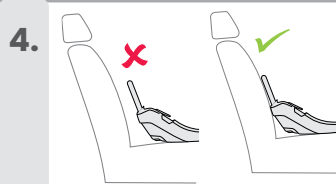

If your car's seat is contoured then you may need to adjust the angle of the base so your baby is not too upright.
Do not have the base too far away from the vehicle seat.

Setup - Adjusting the Base Angle 23

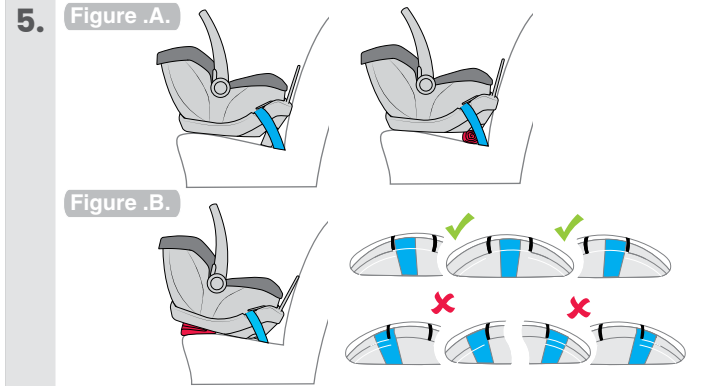

Some vehicle seats have more slope than others. If the correct Base Angle cannot be achieved using the Recline Adjustment Foot (Figure A), it may be necessary to adjust the angle by placing a firm packing between the underside of the base and the vehicle seat (with recline foot stored).

Packing can be a firmly rolled towel.

If packing placement is needed similar to Figure B, ensure the packing cannot become dislodged.

Always ensure any packing is trapped and cannot become dislodged during normal use.

Always check that the level indicator confirms the correct installation angle.

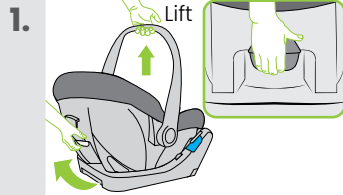

1. Pull up and hold the release lever on the back of the capsule. Lift the capsule from the base using the carry handle.

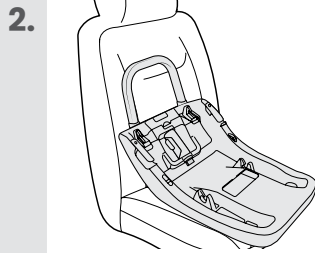

2. Place the base on the vehicle seat. Refer to page 22 to 23 to adjust recline angle.

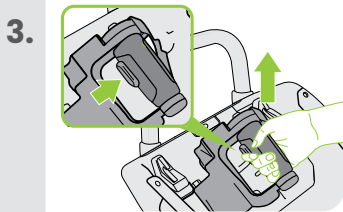

3. Grab the ClickTight handle and squeeze the button. Lift to open the ClickTight handle.

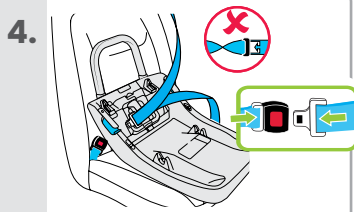

4. Lengthen vehicle seatbelt. **NOTE: Ensure the vehicle belt is not twisted.** Engage the vehicle seatbelt buckle and tongue without twists.

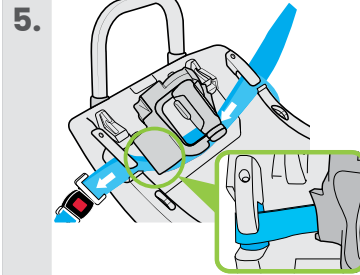

Thread the seat belt under the ClickTight and through the blue REARWARD FACING BELT PATH guide. **NOTE:** Ensure the seatbelt is tucked under the ClickTight completely. Do NOT thread seatbelt through ClickTight handle

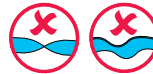
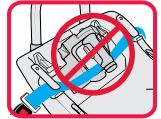

ENSURE THERE ARE NO TWISTS IN SEATBELT.

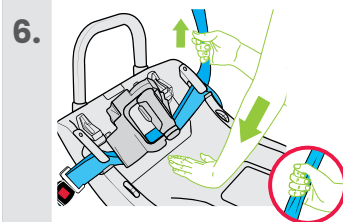

6. Press the base firmly into the vehicle seat while removing slack from the vehicle seat belt. **NOTE:** Do not tighten. **ALWAYS REMOVE SLACK FROM SEATBELT.**

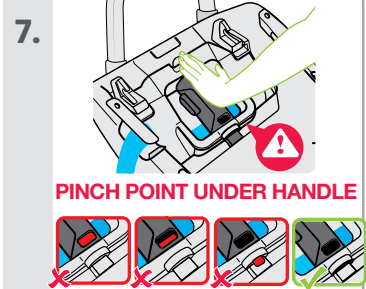

PINCH POINT UNDER HANDLE

Close the ClickTight by pushing down on the ClickTight handle. Ensure window is entirely black. No red visible.

8.

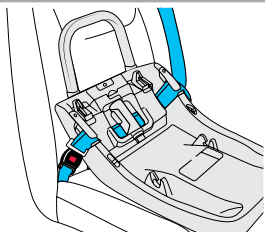

Check vehicle seatbelt is tight and not twisted, and base is secure.

Make sure the base is free of any straps or objects before installing the capsule.

9.

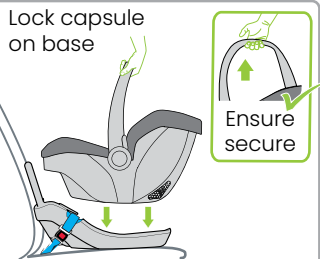

Lock capsule on base

Before locking the capsule to the base, ensure that the harness adjuster strap is not caught underneath it. Lift the carry handle to verify attachment. Handle may be rotated to other latched positions as desired (see page 30).

Ensure secure

10.

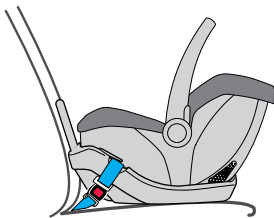

You have now successfully completed the seat belt installation. You are now ready to install the top tether.

A LOOSE INSTALLATION IS DANGEROUS.

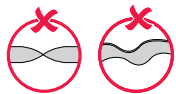

1.

Lengthen strap



- A. Press top tether adjuster button.
- B. Lengthen top tether strap fully, ensure all unnecessary twists are removed.
- C. Place the top tether over the vehicle seatback, and if needed, remove the vehicle headrest. If you cannot remove the headrest, then ensure that the top tether straps are placed through the vehicle headrest.

2.

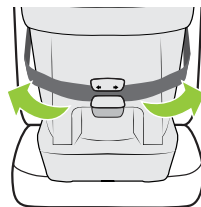

Place top tether loop around capsule and through guide.

NOTE: Top tether loop must not be positioned around or outside carry handle.

3.

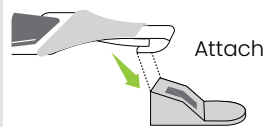

Attach

Connect top tether attachment clip to vehicle anchor fitting.

Check your vehicle manual for the correct anchor fittings in your vehicle

4. Pull to tighten

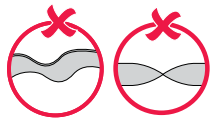
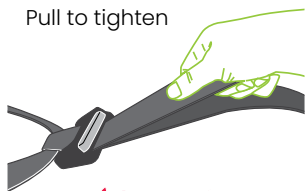

Ensure slack is removed from the top tether straps by pulling top tether adjuster strap. Do not over tighten as it may cause your child seat to lift.

ALWAYS REMOVE SLACK IN THE TOP TETHER AND STORE STRAP.

ENSURE THE TOP TETHER STRAPS ARE NOT TWISTED.

5.

Store strap



Roll up any excess strap and store in the pocket provided on the top tether strap.

6.

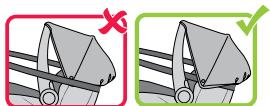
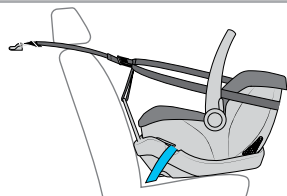

Check angle of child seat is still correct. (See page 22 to 23).

NOTE: Top tether loop must not be positioned around or outside carry handle.

⚠ CAUTION: CHILDREN CAN BE INJURED OR RESTRAINTS AND TOP TETHER STRAP DAMAGED BY UNSECURED CARGO IN A COLLISION. SECURE OR REMOVE HAZARDOUS CARGO BEFORE USING THIS CHILD RESTRAINT.

**IMPORTANT:**

The top tether strap must be fitted at all times.

Always secure the loose end of the top tether strap to prevent it hanging out of the car or being accessible by the child.

THIS RESTRAINT IS NOT SUITABLE FOR USE WHERE THE TOP TETHER STRAP MAY FALL INTO A SPLIT IN THE SEAT BACK OR OFF THE SIDE OF THE SEAT.

ALWAYS ATTACH TOP TETHER HOOK AND REMOVE SLACK IN THE TOP TETHER STRAP.

30 Setup – Adjustment Of Handle Position

The carry handle is designed to rotate in 3 positions as below. The capsule can be used without the base to convert it to a rocker. At the base of the handle there are two large buttons which control the three positions of the handle.

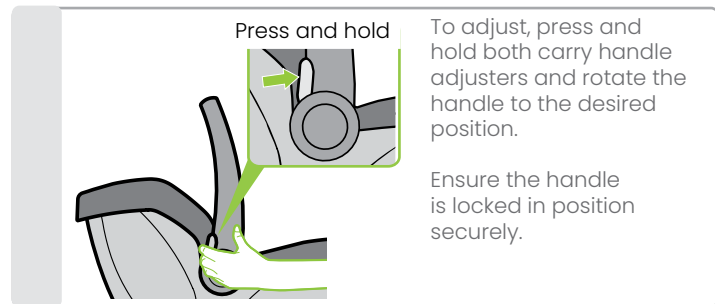
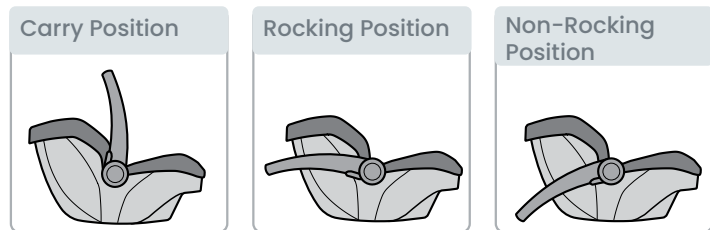

IMPORTANT :

Do not place the Baby Capsule on a table or a work-top where it could fall off.

Check the Baby Capsule handle is latched properly every time you pick up the Baby Capsule, lock it onto the base or use it with a stroller.

Setup – Harness Features 31

For Low Birth Weight Babies – Series BS2300A–C20135 Only

This Baby Capsule is supplied with harness setup to suit an average newborn infant birth weight.

Assess the harness fitment and adjust as necessary by following Setting Up The Harness, see page 34.

However, if your child is of low birth weight or premature then you may need to reposition the harness to the "low birth weight" position, as follows:

Move the crotch strap to the inner slot (see page 32), the lap straps to the inner slots (see page 33) and the shoulder strap to the nearest slot above the shoulders (see page 35). This will provide better support for a low birth weight infant.

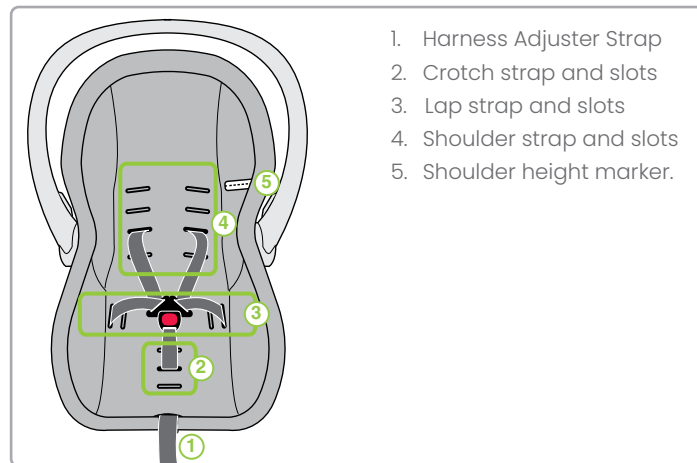

Crotch Strap Options

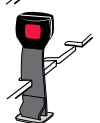
For BS2300A–C20135
For BS2300B–C20135LOW BIRTH
WEIGHTAVERAGE
NEWBORN
INFANTLARGER
INFANT

Your baby capsule is fitted with two or three crotch strap positions; check your Series Number. Correct location of crotch strap will assist to securely position the infant and will help prevent infant from slipping further down the capsule or slumping.



Adjustment of Crotch Strap

Example:

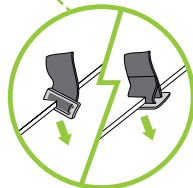
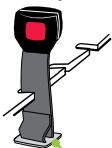

Remove baby from capsule and capsule from base prior to making adjustments.

- Decide which crotch strap position is preferable.
- Turn the metal 3-bar slide on its side and push back through the slots until the crotch strap is free from the capsule.
- Insert the metal 3-bar slide through the preferred slot and loop the strap back up or allow to be at full height (as crotch strap option illustrations show).

Ensure crotch strap is not twisted and positions the red buckle button outwards.

Lap Strap Options – Series BS2300A–C20135 Only

The capsule is fitted with two lap strap positions.

AVERAGE
NEWBORN
INFANT LAP

The lap straps for an average birth weight baby outer lap slot.

LOW BIRTH
WEIGHT LAP

A low birth weight baby may need to use the inner lap strap slot.

NOTE: Move the lap strap to the outer slot as baby grows.

Adjustment of Lap Strap

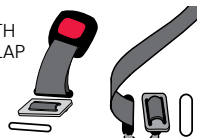
LOW BIRTH
WEIGHT LAP

Remove baby from capsule and capsule from base prior to making adjustments.

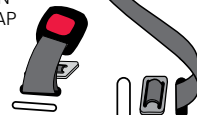
AVERAGE
NEWBORN
INFANT LAP

- Turn each metal 3-bar slide and push back through the slots as shown.

- Insert each metal 3-bar slide through the preferred lap strap slot.

For low birth weight feed from inner slot to middle slot.
For average newborn feed from outer slot to middle slot.
Lap straps metal 3-bar slides are always to be looped to the middle slot.

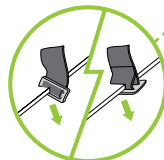

When replacing straps, ensure the straps are not twisted and that all straps are secure.

34 Setup - Setting Up The Harness

The Capsule is fitted with three or four shoulder strap positions depending which series no. capsule you have (see below). You may have to change the shoulder strap loop, slot position and shorten the crotch strap to suit your infant. Always adjust the height of the shoulder straps as the child grows. It is better to change one strap at a time so that the other strap will be a guide for re-assembly.

The shoulder straps must be in the slots which are nearest to the child's shoulders, but not lower than the child's shoulders.

**BS2300A-C20135 - 4 Slot Capsule.
Certified for low birthweight infant compatibility.
Harness Strap Not Below Green Zone**

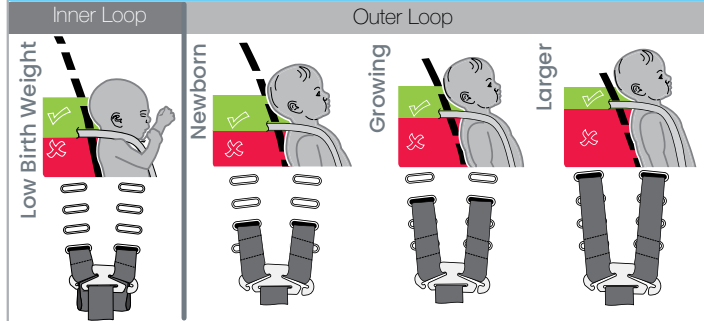

**BS2300B-C20135 - 3 Slot Capsule.
Harness Strap Not Below Green Zone**

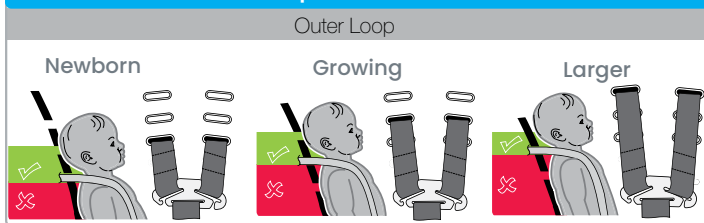

Setup - Setting Up The Harness 35

Positioning Baby Into Capsule

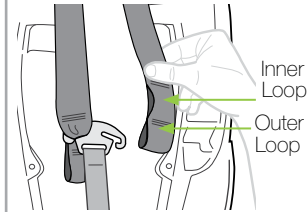

If your child is less than 3kg then you will probably need to use the inner loop to ensure a firm fitting harness.

As the child grows move the shoulder straps to the outer loop when you change the slot position.

The shoulder straps must be in the slots which are nearest to the child's shoulders, but not lower than the child's shoulders.

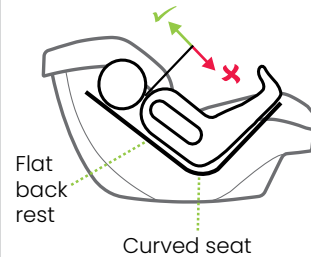

When positioning baby into capsule make sure baby's back is fully supported onto the flat section and the baby's nappy area (bottom) is resting in the bottom curvature as shown. It is recommended that bulky nappies are not used when baby is traveling in the Baby Capsule as they can cause incorrect positioning of the baby's back in the Baby Capsule.

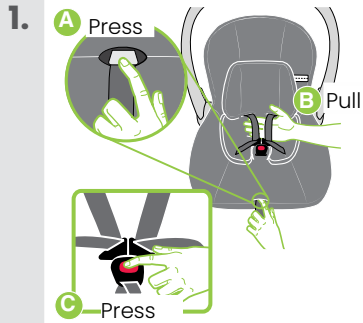

- A.** Press harness adjuster button (located under trim.)
- B.** Place your hand under both shoulder harness straps, then pull shoulder harness straps to lengthen.
- C.** Disengage the buckle by pressing the red button.

2. Remove straps from yoke

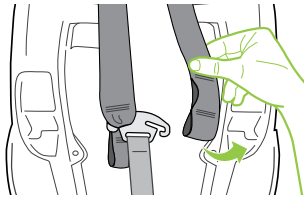

At the rear of the Capsule, remove one of the harness shoulder straps from yoke by slipping strap through slot.

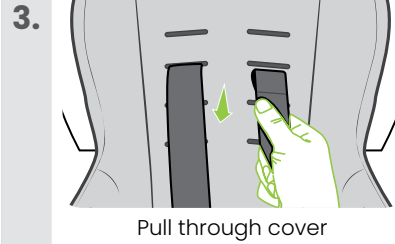

Pull the shoulder strap through cover slot into the seating area of the capsule.

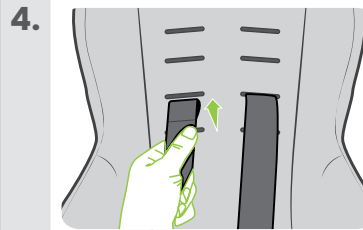

Check which slot is most appropriate for the child's height.

Pass shoulder strap back through desired slot in cover and corresponding slot in the shell. The slot **MUST** position the shoulder strap level with or the next slot above the baby's shoulder.

5. Replace straps to yoke

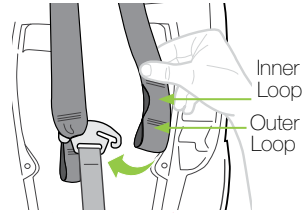

Refit the shoulder straps to the yoke, ensure both straps use either inner loop pair or outer loop pair. Ensure both shoulder straps use the same height slots.

IMPORTANT: Ensure the harness straps are fully secured on the harness yoke.

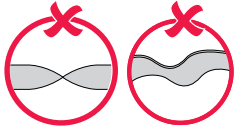

! IMPORTANT:

When replacing straps, cover and padded insert, ensure none of the straps are twisted and that all straps are secure by pulling each harness strap.

6.

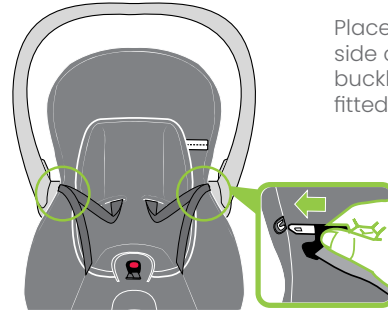

Place buckle tongues to the side of the capsule or into buckle tongue holders (if fitted).

7.

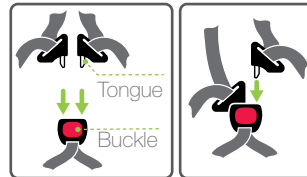

Engage Buckle.

ENSURE BUCKLE IS ALWAYS CONNECTED DURING USE.

ENSURE ALL HARNESS STRAPS ARE NOT TWISTED.

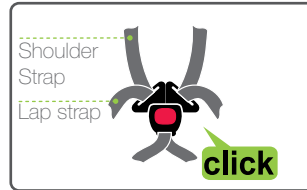

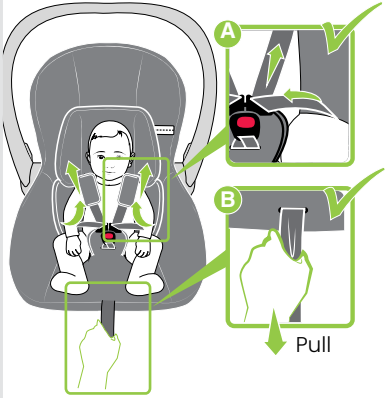
8. 

Remove all slack from the lap strap area (including behind baby's bottom), by pulling up on the shoulder straps.

Pull harness adjuster strap to tighten. Ensure a firm but comfortable fit.

ENSURE ALL HARNESS SLACK IS REMOVED.

! WARNING: DO NOT LEAVE CHILDREN UNATTENDED IN THE CAR.

Do not harness an infant wrapped in a blanket or swaddled as this increases the risk of ejection and injury or death in a crash. The harness needs to fit firmly to the baby, any blanket or other covering may be placed over the harness after it is adjusted. Arms and legs must be free and not bound or wrapped together. The legs must sit on each side of the crotch strap.

1. Lengthen strap 

A Press **B** Pull

A. Press top tether adjuster button.
B. Lengthen top tether strap fully.

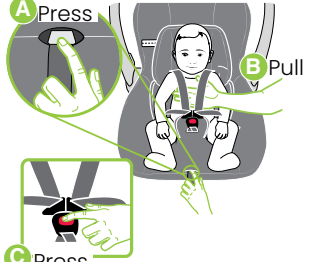
2. 

A Press **B** Pull **C** Press

A. Loosen shoulder harness straps by pressing the harness adjuster button.
B. Pull both shoulder harness straps evenly.
C. Disengage buckle by pressing red button.

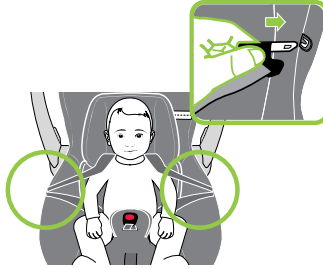
3. 

Place buckle tongues to the side of the capsule or into buckle tongue holders (if fitted).

Lift child from the child seat.

1. Lengthen strap

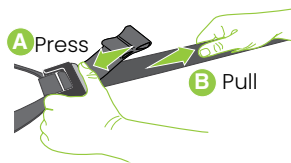

- A. Press top tether adjuster button.
- B. Lengthen top tether strap fully.

2.

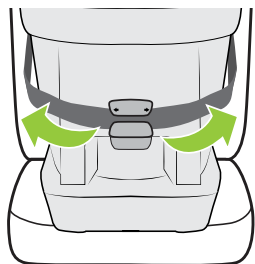

Remove top tether from the capsule.

3.

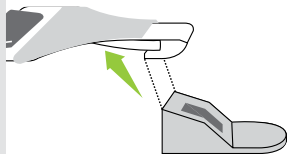

Disconnect top tether attachment clip from vehicle anchorage fitting.

4.

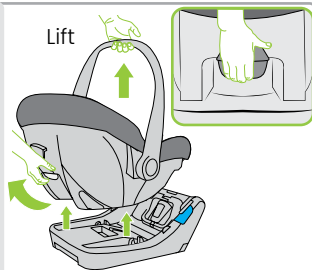

Remove capsule by pulling up and holding the release lever on the back of the capsule. Lift the capsule from the base using the carry handle.

1.

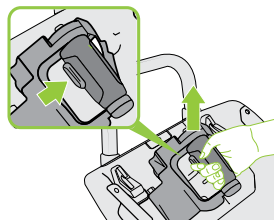

Grab the ClickTight handle and squeeze the button. Lift to open the ClickTight handle.

2.

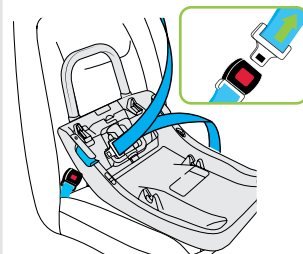

Disengage the vehicle seatbelt buckle. Unthread the vehicle seatbelt and allow the seatbelt to feed back into the retractor.

This baby capsule (without base) is suitable for use on aircraft. The top tether strap is not required to be used to fit the child restraint in aircraft. You do not need the base onboard the aircraft. We recommend that you store the excess strap and hook in the pocket provided and check-in the base with your luggage for use at the destination.

The Baby Capsule must be used in accordance with the aircraft operators procedures, and any directions or instructions from the aircraft operator, pilot or crew.

The Baby Capsule may not fit in smaller aircraft and cannot be used with aircraft seatbelts that contain airbags unless they can be disabled.

Inform the aircraft operator that a child restraint is intended to be used on the aircraft when booking the flight as the child restraint may not be suitable for use in that operator's specific aircraft.

For use of the child restraint in cars in countries other than Australia and New Zealand, The user should consult the country's local authorities, car hire companies, car insurance companies, etc. for advice. The child restraint may not be acceptable for use in all cars.

1.



Position the Capsule rearward facing, align it centrally within the allocated seating position. If possible, lift the armrests out of the way to improve access to installing the aircraft lap belt and to suit the width of the Capsule.

2.

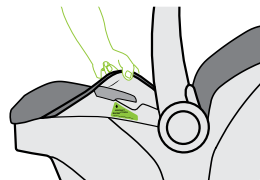

Lift cover to reveal AIRCRAFT SEATBELT PATH label marked in green on both sides.

3.

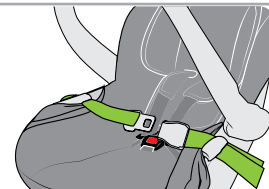

Fully lengthen lap belt and thread into AIRCRAFT SEATBELT PATH as shown, ensuring that lap part is under the guide on each side. Engage lap belt buckle and tongue.

4.

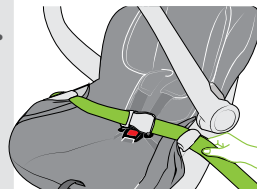

Push down on the Capsule and remove all slack from the lap belt. Pull belt strap to tighten, ensure a firm fit of the Baby Capsule to the seat.

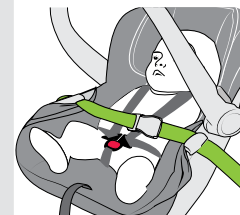

Ensure that any seatbelt or extender buckle does not enter the seatbelt path. Note the airline's safety instructions.

NOTE: Never use the AIRCRAFT SEATBELT PATH in a car. Always replace cover after use.

The Baby Capsule base must be included with 'checked in' luggage (for use after flight). Aircraft label is located on the underneath of the Baby Capsule. It demonstrates suitability for use on aircraft.



This Child Restraint System meets the standards for use in aircraft as recommended by the Civil Aviation Safety Authority of Australia and the Civil Aviation Authority of New Zealand.

Only to be used on aircraft with the permission of the aircraft operator, pilot and crew.

SUITABLE FOR REAR FACING USE

The top tether strap is not required to be used onboard aircraft and should be stowed securely.

Attaching The Car Seat To The Stroller

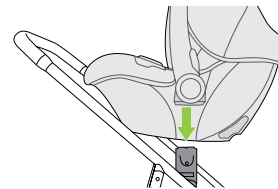

A. Set the brake.

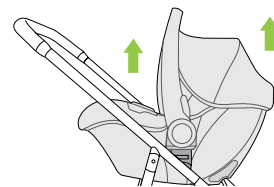

B. Align the baby capsule receivers with the stroller adapters and push onto the frame until you hear an audible click.

C. Lift the baby capsule to ensure it is firmly fitted to stroller.

Removing The Car Seat From The Stroller

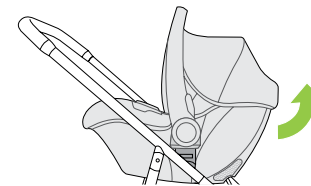

A. Pull and hold the release lever on the back of the baby capsule and lift to remove from stroller.



For the capsule, and detailed compatibility with strollers scan the QR code for more information.

Regular Care Of This Restraint:

Please check the following items regularly to ensure the safety of your child.

- A. Check the condition of the harness straps, i.e. No damage or fraying.
- B. Check the condition of the seat structure, i.e. No cracks or other forms of damage.
- C. Check the harness adjuster is operating correctly.
- D. Ensure the buckle is free of fluff, liquid or other matter that may enter the buckle opening. Clean the buckle if it is difficult to engage. See next page.
Immediate repair is required if any of the above issues are observed. Contact Britax® Customer Service 1300 303 330.
- E. Regularly check the restraint components, straps and other fittings for correct function and condition. If faulty, cease using and seek repair by Britax®.
- F. Protect all webbing from abrasion and cutting by sharp corners and edges.
- G. Regularly vacuum under the seat cover to remove accumulated food etc. Pay particular attention to Lower Adjuster area as food ingress can allow webbing to slip.

Cleaning Child Seat

HARDWARE: Use only mild soap to clean all metal and plastic parts of your child's restraint, using a damp sponge or cloth. Do not use chemicals or cleaning agents. Do not try to place any hardware into a washing machine.

STRAPS/HARNESS: We recommend spot cleaning straps and harness with a damp sponge or cloth using only cold or warm water. Never place any straps or harness into a washing machine or tumble dryer.

Washing Care For Cover

- Gentle Cold Machine Wash
- Do Not Bleach, Soak Or Wring
- Do Not Tumble Dry
- Do Not Dryclean
- Dry Flat In Shade
- Do Not Iron

Buckle Operation

To ensure the buckle remains operational, the inside of the buckle must be kept free of liquids, sand, dirt, fluff, food or similar substances. If the buckle is not operating or you do not hear a strong audible click when the second tongue is inserted then the buckle needs to be washed or replaced. The buckle is fully engaged when both tongues are inserted and a 'click' is heard. Contact Customer Service for assistance.

Clean Harness Buckle:

If sticky liquids such as baby formula, fruit juice, etc. get inside your harness buckle, it may become sluggish. An indication of a sluggish harness buckle is that you cannot hear a click when engaging the second harness tongue. To restore the harness buckle to good working order it needs to be cleaned as follows:

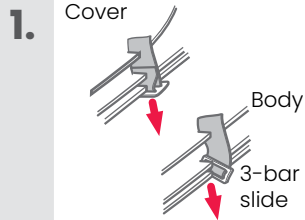

Remove the harness buckle from the underside of the capsule. Pull each crotch strap 3-bar slide, turn the 3-bar slide on its side and push back through the slot.

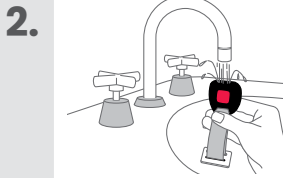

Place the harness buckle under warm (max. 40 degrees celsius) running water as shown below. Let the water run through the mouth of the buckle for five minutes. Check the harness buckle is clean by engaging the harness tongues and buckle several times until you hear a click.

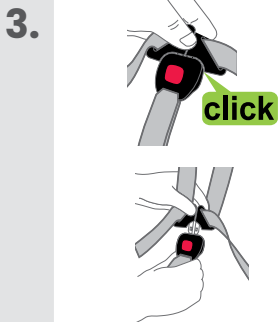

If you still cannot hear a strong audible click then repeat the cleaning process several times. Refit the harness buckle to the capsule ensuring the red button facing outwards and the 3-bar slide is fed through the same slots. If the harness buckle cannot be returned to its original working condition then contact Britax Customer Service for assistance.

Cover (Style May Vary)

The restraint has a flame retardant cover which is removable for cleaning. Cleaning instructions are on the care label attached to the cover. If fluffy cover is fitted then washing the cover prior to use will remove excess fluff.

The cover has been designed to protect your child when seated in the restraint. Care should be taken if children either eat or drink while in the restraint as some food or drink products may cause damage or marking to the cover. Wash or clean immediately.

Do not pull sticky items from covers as the cover may be damaged - soak in water and gently remove.

To keep your product looking its best, take care when using while wearing jewelry or other items that could snag.

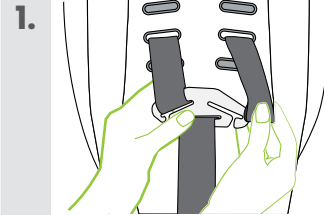

To Remove The Cover

To remove canopy refer to page 60.

Remove the harness straps. See page 35.

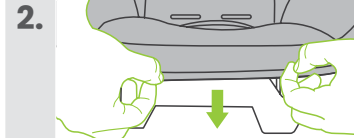

Untuck cover from around front of the seat.

3.

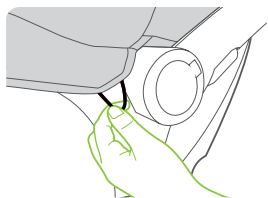

Undo the elastic bands on the side of the capsule on both sides.

4.

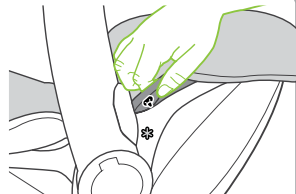

Pull out the press studs securing the cover to the seat on both sides.

5.

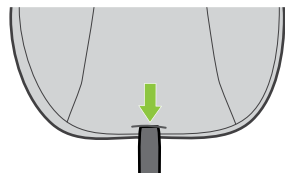

Feed the crotch buckle, harness adjuster strap and shoulder straps through the slots in the cover.



6.

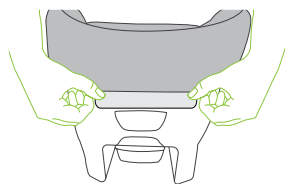

Lift out plastic flap from the shell edge at the back of the capsule.

7.

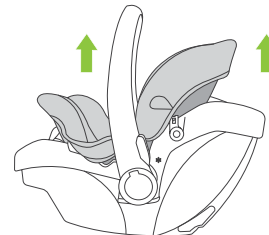

Pull the seat cover and lift away from the shell.

ONLY USE BRITAX SAFE-N-SOUND SEAT COVERS AND ACCESSORIES THAT ARE DESIGNED AND TESTED FOR USE WITH THIS PRODUCT.

1.

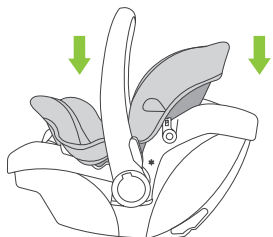
**To Replace The Cover**

Fit the cover onto the top of seat shell and tuck into the channel around the capsule.

2.

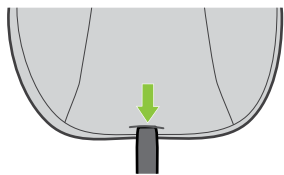

Pull the harness adjuster strap through the cover.

3.

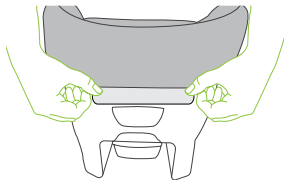

Place plastic flap tucked into the edge around back of capsule.

4.

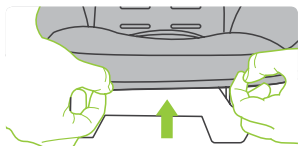

Tuck cover around front of seat.

5.

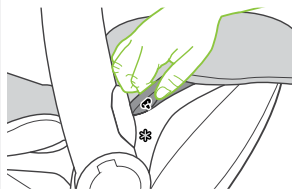

Secure press studs at side of seat.

6.

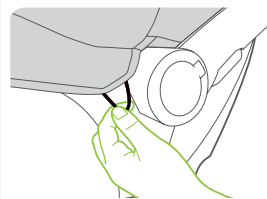

Secure elastic bands on the side of the capsule on both sides.

7.

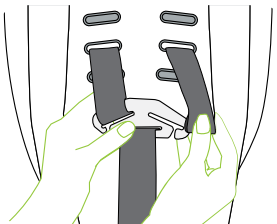

Feed the crotch buckle (see page 32) as well as the shoulder straps through the slots in the cover. Refer to page 35.

NOTE: Ensure harness straps are not twisted.



To replace Canopy refer to page 60.

ONLY USE BRITAX® SEAT COVERS AND ACCESSORIES THAT ARE DESIGNED AND TESTED FOR USE WITH THIS PRODUCT.



VERY IMPORTANT:

Only replace the cover with Britax® supplied replacement cover with identical shoulder height markers or a replacement cover meeting AS/NZS 8005.

The following instructions apply to accessories that may be supplied with this restraint at point of purchase. The accessories are for comfort use only. Use of aftermarket accessories, which are accessories not provided with this child restraint, can reduce the safety provided by the child restraint and may cause injury or death. Always follow the instructions covering the use of accessories provided with this child seat and the instructions provided with the accessory. If an aftermarket accessory is used that is not recommended by Britax®, ensure that the accessory is compliant with AS/NZS 8005 and is stated as suitable for use with this specific child restraint.

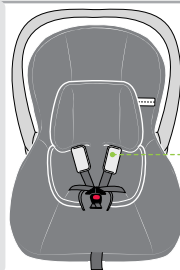

Shoulder Pads

Shoulder Pads (if supplied)

Shoulder Pads give extra comfort for your child when using the harness. They're easy to remove and it makes washing them a breeze - unclip the studs to clean them and fit them back onto the shoulder harness straps once done.

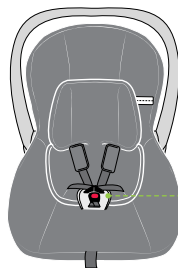

Crotch Pad

Crotch Pad (If supplied)

The crotch pad is designed to provide extra comfort for baby or child and is fitted to the crotch buckle straps. It can be removed when the buckle is disengaged.

- A.** To fit the Crotch pad, Feed the crotch buckle through the loop at the base of the crotch pad and pull out the crotch buckle.
- B.** To remove, simply slide the crotch pad off the buckle.

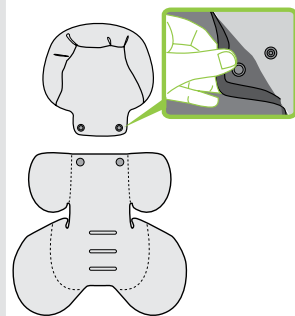

Head Pillow (if supplied)

This head pillow is designed for additional comfort around smaller baby's head. Remove when outgrown or shoulder harness has reached top slots. The pillow is attached to the comfort insert with press studs on the back of the pillow.

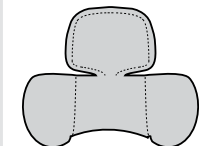

Padded Insert (if supplied)

- Style may vary

The comfort insert is designed for additional comfort for smaller babies. It can be removed once baby's shoulders reach the shoulder height marker to allow longer use of the capsule.

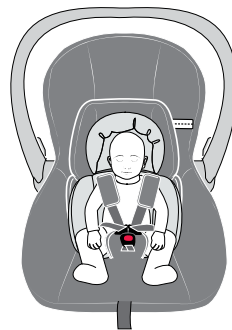
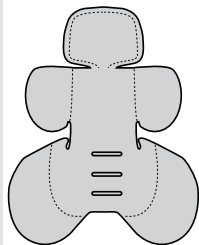

- A. Disconnect buckle and place insert under shoulder and lap straps.
- B. Feed the crotch strap through the flap in the padded insert and re-connect buckle.

Discontinue use if the padded insert is a tight fit or creates discomfort.

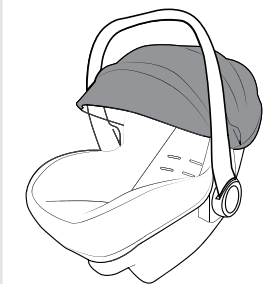

Canopy (if supplied)

Large sun canopy for protection whilst out and about.

To Remove Canopy

- A.** Press button on canopy rod.
- B.** Detach press stud at the back of the canopy from canopy mount.
- C.** Lift up the canopy from both sides and remove.

To Replace The Canopy

- A.** Slide the canopy into the slot until button pops through the opening.
- B.** Pull canopy over back of seat end and attach press stud.
- C.** Attach press studs on both sides of cover.

Note: If fitted with drape, extend drape from under canopy visor. Pull out and attach to magnets on either side of the baby capsule.

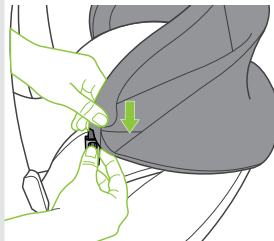

Canopy Drape (if supplied)

Roll up drape and store in pocket under canopy.

IMPORTANT: Always allow clear observation of the infant when travelling in a vehicle.

Stretch Canopy (if supplied)

To Fit And Use The Canopy

- A.** Fit the canopy over the capsule with elastic at the end.
- B.** Loop elastic around carry handle and clip in press studs. Check the elastic around the back of the capsule has not lifted.
- C.** The canopy can be rotated to cover the baby or folded by rotating to the desired position using the carry handle.

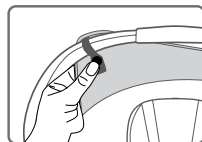
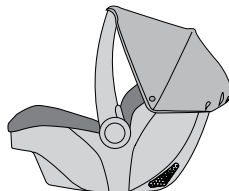

To Remove Canopy

- A.** Unclip the press studs from carry handle and remove canopy.

IMPORTANT: Always allow clear observation of the infant when traveling in a vehicle.

62 Installation Of Vehicle Upper Anchor Point

Consult the vehicle owner's handbook for location of anchorage fittings or anchorage points and the possible use of spacers. Some vehicles may have an anchor fitting fitted by the vehicle manufacturer. If anchorage points cannot be found refer to car manufacturer or local child restraint fitting station or traffic authority for optimum position of upper anchorage point and the use of spacers.

TOP TETHER STRAP

IMPORTANT:

THE ATTACHMENT CLIP COVER MUST ALWAYS BE USED AS IT PREVENTS THE RISK OF INCORRECT FITMENT OF THE ATTACHMENT CLIP TO THE UPPER ANCHORAGE POINT. BEFORE EACH USE OF THE RESTRAINT ALWAYS ENSURE THAT THE ATTACHMENT CLIP IS CORRECTLY ENGAGED TO THE UPPER ANCHORAGE POINT AND NOT HOOKED TO OR FITTED TO, ANY OTHER OBJECT. THIS IS ESPECIALLY IMPORTANT IN VEHICLES SUCH AS STATION WAGONS, VANS, HATCH BACKS OR VEHICLES WITHOUT A FIXED PARCEL SHELF, SINCE THE ANCHOR POINT IS USUALLY NOT VISIBLE.

IMPORTANT INSTALLATION NOTE:

In some vehicles the upper anchorage point in the rear vertical panel can only be installed in one way. Please refer to vehicle owner's handbook or a child restraint fitting station for correct method.

Installation Of Vehicle Upper Anchor Point 63

Extension Straps

Length 300mm (Use Britax Safe-n-Sound part 0035 or 0291).
Length 600mm (Use Britax Safe-n-Sound part 0036 or 0290).
Available from all major child restraint retailers.

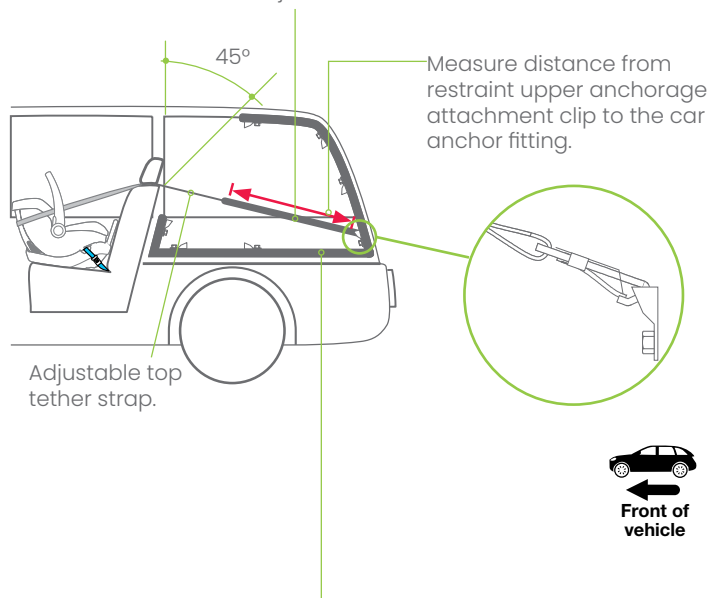

The shaded areas of this diagram illustrate the possible locations of the upper anchorage point (car anchor fitting). Within each shaded area is an upper anchorage point showing the correct way to install the fitting. Ensure the upper anchorage point is aligned as illustrated unless stated otherwise in the vehicle owner's handbook.

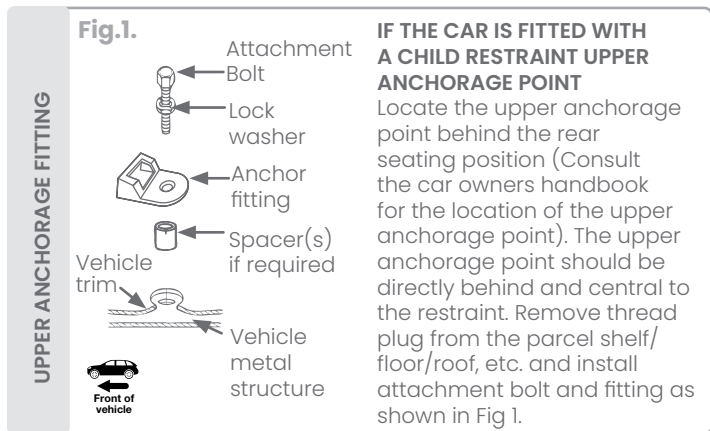

CAUTION: DO NOT OVERTIGHTEN ATTACHMENT BOLT. OVERTIGHTENING MAY FRACTURE OR BREAK BOLT. MAXIMUM TORQUE IS 20 Nm(14.75 ft.lb.)

Note: Minimum of five full turns of attachment bolt is required before tightening force is applied.

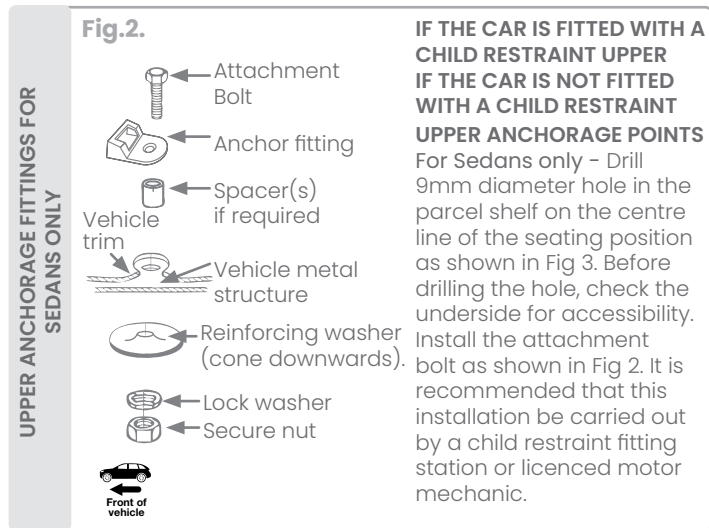

For vehicles other than Sedans - In Australia, consult your nearest child restraint fitting station or traffic authority for vehicle inspection to find the best, correct position for the placement of the upper anchorage point, and for the correct attachment bolt length and use of spacers. In New Zealand, consult the agent for the vehicle. Note to Queensland purchasers: The installation of anchorage points must be approved by authorised officers appointed by Queensland Transport. Authorised officers can be sourced from all Queensland Transport Customer Service and Queensland Ambulance Service Centres.



NOTE: Marking on the top of a Grade 5 Bolt. Do not use any bolt without these marks.

ONLY USE A 5/16 UNC GRADE 5 BOLT. IF THE BOLT IS NOT THE CORRECT LENGTH THE CAR MANUFACTURER'S HAND BOOK CAN PROVIDE ADVICE ON THE CORRECT LENGTH BOLT.

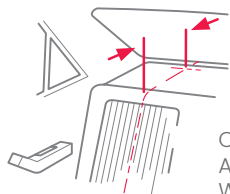

200mm min.



WARNING

CHILD RESTRAINTS MUST NOT BE ATTACHED TO UNSOUND METAL OR TO WOOD, OR SYNTHETIC STRUCTURES. WHEN DRILLING 9 MM HOLE DO NOT DRILL THROUGH FUEL LINES, FUEL TANKS, ELECTRICAL WIRING, OR RADIO SPEAKERS. WEBBING STRAPS MUST BE PROTECTED FROM SHARP CORNERS AND EDGES. THE ANCHOR FITTING MUST BE USED ONLY AS DESCRIBED ABOVE. IT MUST NOT BE HOOKED ONTO ANY OTHER OBJECT.

Fig.3.

Car Installation Accessories

(From retailers of Britax Safe-n-Sound® products)

Extra Anchor Kits: Available for using the restraint in additional cars.
Re-order no: 0038 or 0289

Extension Straps: May be required for cars without a fixed parcel shelf.

Re-order no: 0035 or 0291 (Length 300mm) or
0036 or 0290 (Length 600mm)

Crash Exchange

We would never want you to experience an accident, but unfortunately accidents do happen.

If you experience an accident you may be eligible for a free replacement.

The Britax Safe-n-Sound® Crash Exchange Program is a voluntary program designed to ensure our children are safe and that any seat that may have experienced a severe crash is taken out of the market.

There is no method of determining if the restraint has been damaged in a severe crash, so the restraint should be destroyed as the crash may reduce the child restraint's ability to perform. Since its inception in 2006, the Crash Exchange program has helped hundreds of families ensure their children have new restraints and that the restraints are not sold second hand placing others at risk.

If your restraint has been involved in a severe crash, you should destroy the restraint even if no damage is obvious. Restraints are eligible for exchange if they have been involved in a severe crash in Australia or New Zealand and meet all stated criteria. (A severe crash is considered as being one where the main body structure of the vehicle is distorted).

The Britax Safe-n-Sound® child safety restraints are available for exchange under this program.

Contact your insurance company for further details. Your insurance company may require you to keep the child restraint for assessment, **but do not use the child restraint after a severe crash.** Refer to the Britax® crash exchange website for more details.

Our Crash Exchange Terms and Application form are accessible on our website. Please visit britax.com.au for further information.



All Britax Safe-n-Sound® child restraints are manufactured to Australian/New Zealand Standards AS/NZS1754-2013 which require us to advise users of child restraints to "Destroy the entire restraint if it has been in use in a severe crash, even if no damage is obvious". The joint Australian/New Zealand Standards committee CS/85, advise that this statement applies whether a child was in the child restraint or not. A severe crash, we consider as being one where the main body structure of the vehicle is distorted. There is no method of determining if the restraint has been damaged and we concur with the Australian/New Zealand Standards in recommending destruction of the child restraint. This notice is to advise you of the requirements of the Australian/New Zealand Standards and our obligation in complying with the standards.

Please assist the owner of this restraint in their claim.

Australia

Britax® Childcare Pty. Ltd.

A.B.N 55 006 773 600

Head office and registered address:

Level 4, 650 Lorimer Street, Port Melbourne, VIC, 3207

P.O. Box 5119 Garden City, VIC, 3207

Customer Service 1300 303 330

Email: aunz-support@britax.com

britax.com.au

New Zealand

Britax® Childcare (NZ) Ltd.

Customer Service 0508 688 822

Email: nzoffice@britax.com

britax.co.nz

International Enquiries

Contact your local Distributor

Britax and Britax Safe n Sound are registered trademarks of Britax Childcare Pty Ltd. ABN 55 006 773 600



Scan QR code for features, how to use and installation.

Series No. BS2300A-C20135
Series No. BS2300B-C20135

P/No.2204060/B

WARRANTY

Our goods come with guarantees that cannot be excluded under the Australian Consumer Law. You are entitled to a replacement or refund for a major failure and compensation for any other reasonable foreseeable loss or damage. You are also entitled to have the goods repaired or replaced if the goods fail to be acceptable quality and the failure does not amount to a major failure. For the full terms of the Warranty refer to the Britax® website www.britax.com.au/service-support/warranty, www.britax.co.nz/service-support/warranty In our constant pursuit of excellence, we may alter this product and specification without notice. This product may be covered by Australian and International patents and designs or pending applications.

Britax Safe-n-Sound®, Safe-n-Sound®, Babylove® and Hipod® are registered trademarks of Britax® Childcare Pty Ltd.

All Britax Safe-n-Sound®, Safe-n-Sound®, Babylove® and Hipod® model names are trademarks of Britax® Childcare Pty Ltd.