

safe·n·sound



ULTRA LIGHTWEIGHT STROLLER

IMPORTANT: KEEP THIS BOOKLET IN A SAFE PLACE FOR FUTURE REFERENCE

Series LX5019

STROLLER SECTION

- 4 STROLLER WARNINGS
- 5 IMPORTANT NOTES
- 6 MANUAL HANDLING TECHNIQUES
- 7 STROLLER FEATURES

STROLLER ASSEMBLY

- 8 OPENING THE STROLLER FRAME
- 10 ATTACHING & REMOVING THE REAR WHEELS
- 10 ATTACHING & REMOVING THE FRONT WHEELS

STROLLER OPERATION

- 11 USING THE SHOULDER HARNESS PADS
- 11 USING THE CANOPY
- 12 USING THE BRAKES
- 12 USING THE FRONT WHEEL SWIVEL LOCK
- 13 ADJUSTING THE BACKREST
- 14 SECURING YOUR CHILD HARNESS
- 15 ADJUSTING THE HARNESS
- 16 OPENING THE HARNESS
- 16 ADJUSTING THE SHOULDER HARNESS HEIGHT
- 17 USING THE TETHER STRAP
- 18 USING THE STROLLER
- 19 FOLDING THE STROLLER

CARE & MAINTENANCE

- 20 GENERAL MAINTENANCE & REPAIR
- 21 CLEANING

WARRANTY

- 23 MAKING A WARRANTY CLAIM
- 24 AUSTRALIAN CONSUMER LAW
- 24 SAFE-N-SOUND® WARRANTY
- 24 INTERNATIONAL WARRANTY

- 25 NOTES

Always follow the manufacturers instructions.

Read all instructions carefully before assembly and use of this stroller.

The correct use and maintenance of this product is essential.**⚠ WARNING**

- FOLLOW THE MANUFACTURER'S INSTRUCTIONS
- PUT ON ALL THE BRAKES WHENEVER YOU PARK THE STROLLER.
- DO NOT LEAVE CHILDREN UNATTENDED.
- DO NOT CARRY EXTRA CHILDREN OR BAGS ON THIS STROLLER
- MAKE SURE CHILDREN ARE CLEAR OF ANY MOVING PARTS IF YOU ADJUST THE STROLLER, OTHERWISE THEY MAY BE INJURED.
- THE VEHICLE IS NOT TO BE USED AS AN UNSUPERVISED SLEEPING ENVIRONMENT.
- DO NOT USE ANY ACCESSORIES OTHER THAN THOSE APPROVED FOR USE WITH THIS STROLLER BY BRITAX.
- IT IS UNSAFE TO USE ACCESSORIES NOT APPROVED FOR USE WITH THIS STROLLER.
- THE MAXIMUM WEIGHT OF THE CHILD USING THIS STROLLER IS NOT TO EXCEED 20KG.

FOR IMPORTANT NOTES AND WARNINGS ON ACCESSORIES

REFER TO THEIR INDIVIDUAL SECTIONS IN THIS BOOK OR THE INSTRUCTION MANUAL INCLUDED WITH THE INDIVIDUAL PRODUCTS. THE MAXIMUM WEIGHT VARIES FOR EACH ACCESSORY.



THIS **CAUTION** SYMBOL IS SHOWN AT CERTAIN STEPS IN THIS INSTRUCTION MANUAL TO HIGHLIGHT THE DANGER OF BEING INJURED BY MOVING PARTS.

IMPORTANT NOTES

- Use great care when using the stroller on stairs, escalators, travelators or other moving surfaces.
- It is recommended to remove the child from the stroller before going up or down stairs or escalators.
- Do not allow children to stand on the seat.
- Do not hang bags unless they are supplied or goods from the handle as this could cause the stroller to tip over.
- Do not leave the stroller and its accessories near an open fire or exposed flame.
- Do not place more than 6kg in the basket.

THE SMART LIFTING TECHNIQUE

This technique can be used to pick up small light loads from low levels.

SIZE UP THE LOAD

- Assess the load (size, shape and weight).
- Assess whether the load needs to be moved.
- Where is it going to be placed, check that there are no obstructions.
- Assess whether mechanical or human assistance is required.

MOVE THE LOAD AS CLOSE TO THE BODY AS POSSIBLE

- A load is heavier to lift or carry if it is not close to the body.
- The whole hand should be used to ensure a firm grip.

ALWAYS BEND YOUR KNEES

- Maintain balance.
- Keep feet apart and in a comfortable position.
- Minimise lower back bending.
- Bend knees preferable at as large an angle as possible but not at a right angle use a semi squat in preference to a full squat.

RAISE THE LOAD WITH YOUR LEGS

- Achieve the lift smoothly and without jerkiness.
- Maintain the normal curvature of the spine to allow the force of the load to be distributed evenly from the spine to the pelvis.

TURN YOUR FEET IN THE DIRECTION THAT YOU WANT TO MOVE THE LOAD

- Avoid unnecessary bending, twisting and reaching.
- Change direction by turning your feet and not your back.
- To set the load down, squat down, keep your head up and
- Let your legs do the work.

Remember to 'THINK TALL' chest lifted, shoulders relaxed, chin tucked in and head level.

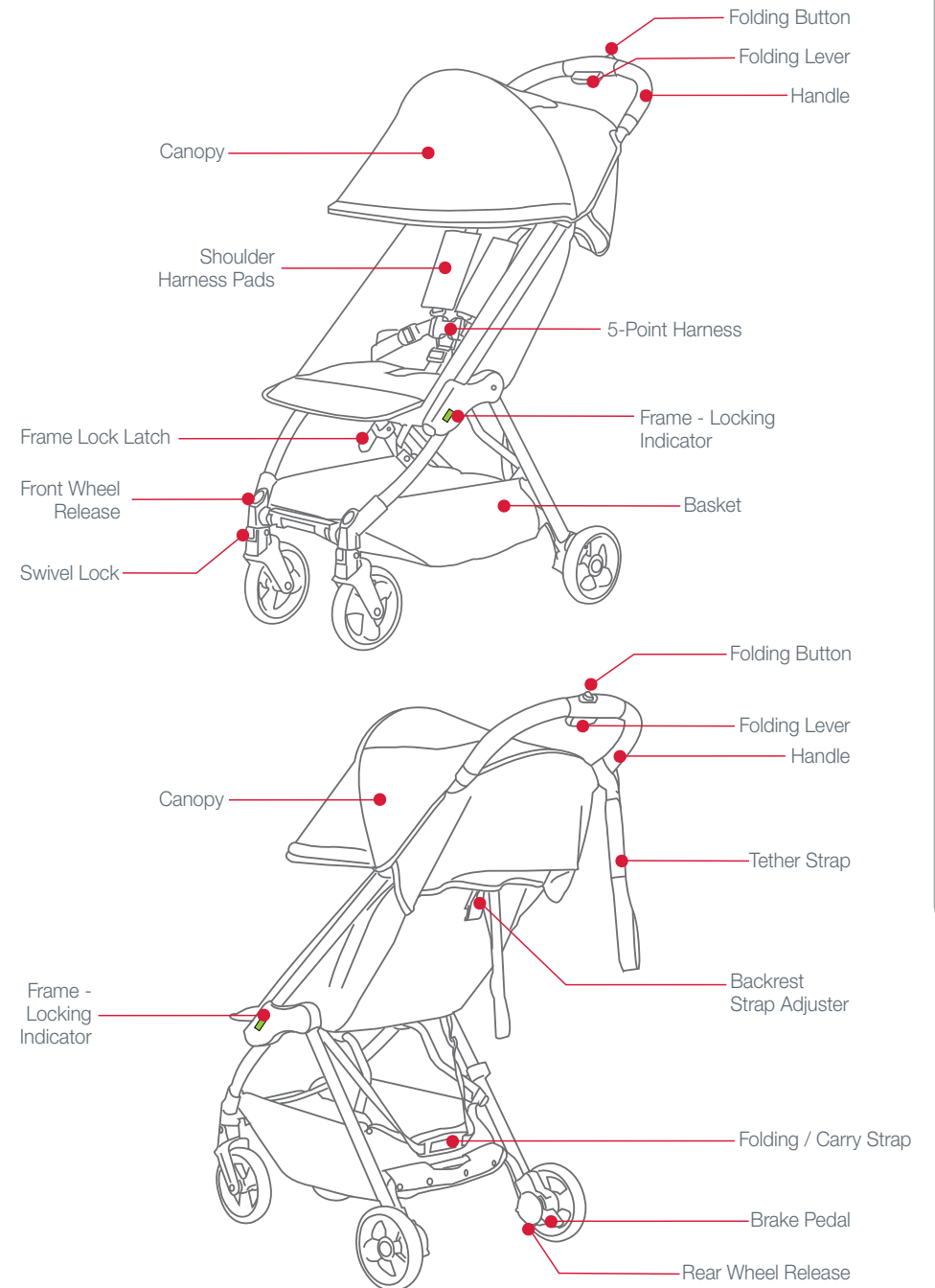

IMPORTANT NOTES

PLEASE REFER TO PAGE 6 FOR SMART LIFTING TECHNIQUES.

- Release the storage latch with due care and open the frame.
- When opening the stroller, be aware of the danger of being injured by moving parts and locking devices during the process. Keep all hands and limbs clear of these parts.
- There is potential for fingers or parts of the body to be injured when the stroller is being unfolded, due care should be exercised.
- Keep children clear of the stroller when unfolding the stroller.
- Open the stroller slowly and be careful where you place your hands. Keeping your hands on the handle is the best way to unfold the stroller.

OPENING THE STROLLER FRAME



A Ensure the carry strap is out of the way and hangs freely before opening the stroller frame.

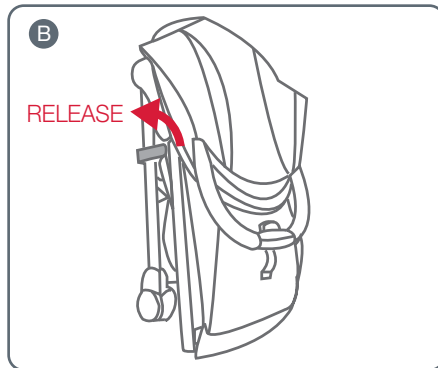

B Release on the frame lock and open the frame.

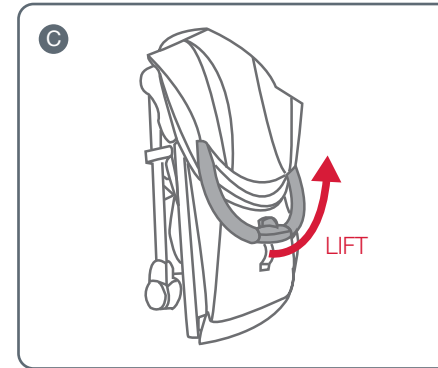

C Open the frame by lifting the handle.

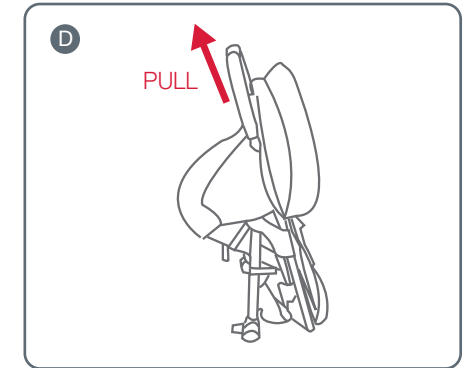

D Continue to pull the handle upwards.

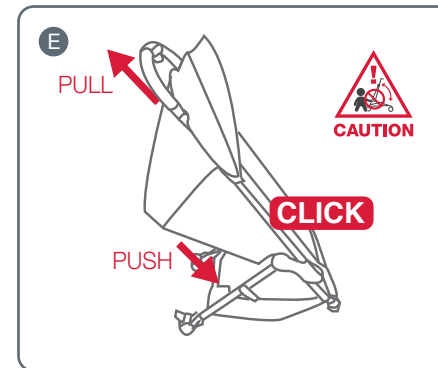

E To assist the opening, push down the back of the basket with your foot while pulling the handle upwards until frame is locked.

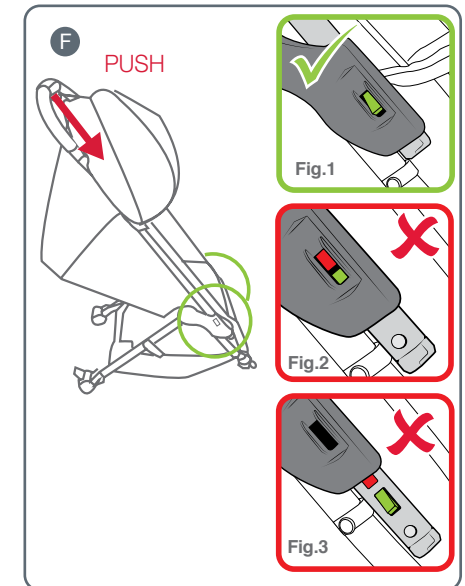

F To ensure that the stroller frame is locked correctly there are green and red indicators on both sides as shown. The stroller is correctly locked when only green is visible in the plastic housing as figure 1.

Push down the handle to make sure the stroller frame is fully opened and locked. If not please repeat the steps D and E.

ATTACHING OR REMOVING THE REAR WHEELS

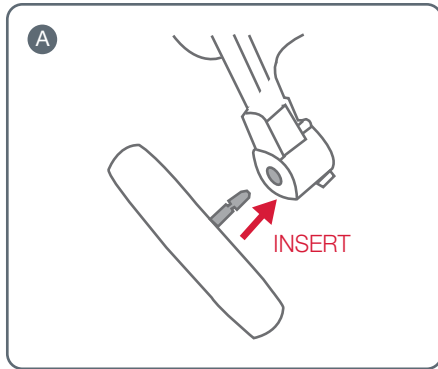

A To attach the rear wheels, insert each wheel axle into rear wheel housing and push in until locks. Pull on the wheel to ensure it is locked.

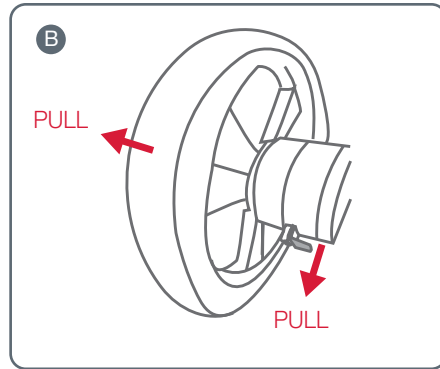

B To remove the rear wheels, pull the metal latch downwards on the underneath of the rear wheel housing and then pull the wheel out.

ATTACHING OR REMOVING THE FRONT WHEELS

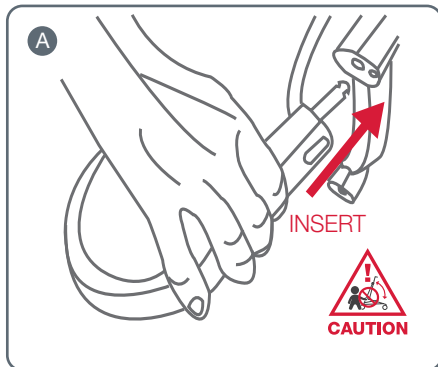

A To attach the front wheels, insert each wheel into wheel housing and push in until locks. Pull on the wheel to ensure it is locked.

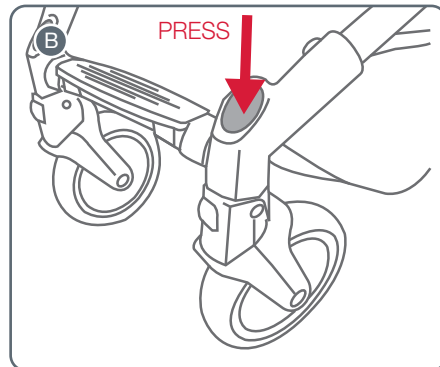

B To remove the front wheels, press the quick release button on the top of the front leg mouldings.

USING THE SHOULDER HARNESS PADS

IMPORTANT NOTE

Ensure that the shoulder straps are fitted through the appropriate harness slots to suit your child's seated shoulder height.

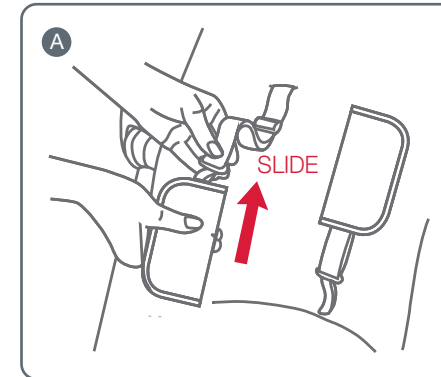

A Slide the shoulder harness pads onto the shoulder harness straps and adjust to the position which fits comfortably on the child.

USING THE CANOPY

IMPORTANT NOTE

The sun is very strong. **DO NOT LEAVE YOUR CHILD EXPOSED TO THE SUN.** The canopy or hood on this product will not give your child total protection from the harmful rays of the sun.

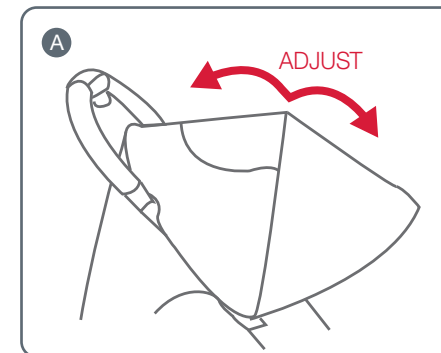

A To adjust the canopy, open by pulling forward, or close by pushing the canopy backward.

USING THE BRAKES

⚠ WARNING

ALWAYS APPLY THE BRAKES WHEN THE STROLLER IS STATIONARY.

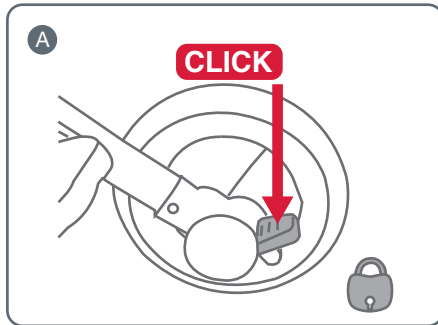

A To engage the brake, step on the red brake pedal until you hear a 'click'. Ensure the brake is engaged.

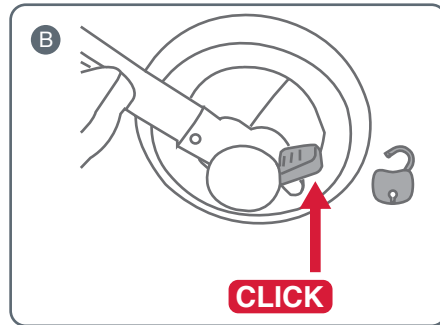

B To disengage the brake, push the red brake pedal up until you hear a 'click'.

USING THE FRONT WHEEL SWIVEL LOCK

PLEASE NOTE

Always lock the swivel wheels when using the stroller on rough surfaces as this will minimise wheel wobble. The swivel wheels should only be locked when the wheels are in the trailing position (wheels under frame).

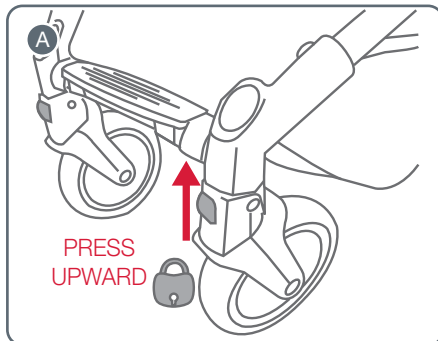

A To lock the front wheels into the fixed position, press the swivel lock up on both wheels until they lock into position.

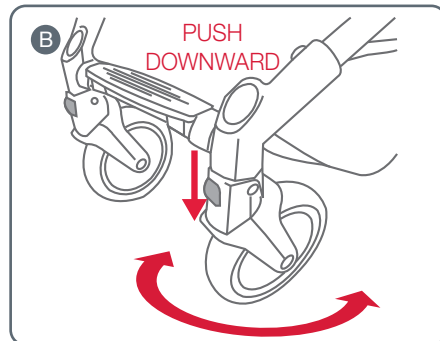

B To allow the wheels to swivel, push the swivel wheel lock down on both wheels until they swivel freely.

ADJUSTING THE BACKREST

⚠ WARNING

- THE UPRIGHT POSITIONS ARE NOT SUITABLE FOR USE WITH CHILDREN LESS THAN 6 MONTHS OLD.
- THE LOWEST RECLINE POSITION SHOULD BE USED TO TRANSPORT BABIES. THE BACKREST CAN BE ADJUSTED TO A MORE UPRIGHT POSITION AS THE CHILD GROWS OLDER AND IS ABLE TO SUPPORT IT'S HEAD WITHOUT ASSISTANCE.

PLEASE NOTE

If the child is sitting in the seat, support the backrest as it reclines.

If you have difficulty adjusting the backrest you may need to remove the child from the seat to allow you to raise or lower the backrest with ease.

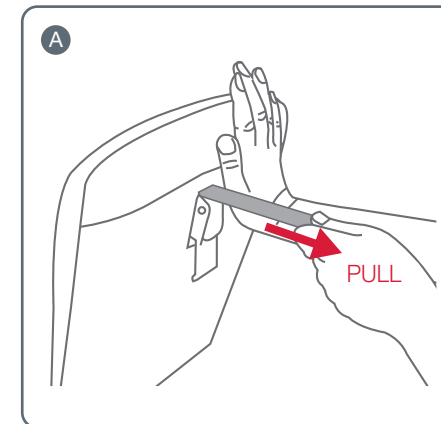

A To raise the backrest, support the backrest with one hand and pull the strap until designed position.

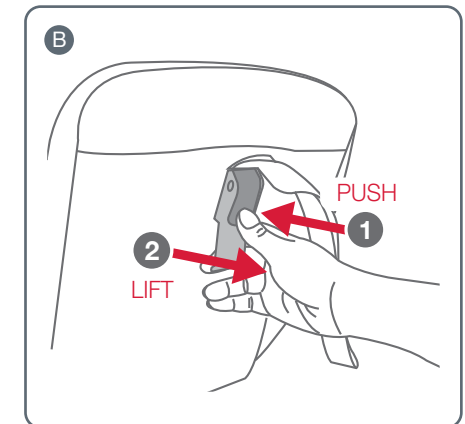

B To lower the backrest, push the button and pull the lever then slowly lower the backrest.

SECURING YOUR CHILD HARNESS

⚠ WARNING

- ENSURE YOUR CHILD IS SECURED WITH A CORRECTLY ADJUSTED HARNESS.
- THE ADJUSTED HARNESS SHOULD CLOSELY FIT THE CHILD.
- NEVER LEAVE THE HARNESS BUCKLED WHEN NOT FITTED TO A CHILD IN THE STROLLER, BECAUSE THE HARNESS CAN FORM LOOPS WHICH MAY POSE A STRANGULATION HAZARD.
- WHEN HARNESS IS NOT IN USE, DISCONNECT SHOULDER STRAPS FROM THE WAIST STRAPS AND BUCKLE TO PREVENT STRANGULATION.
- A five point harness is provided to restrain your child.
- Buckle tongues separate for added safety.
- To reconnect buckle tongues and to secure the child in the harness please follow the steps below carefully.

PLEASE NOTE

Each waist buckle tongue has a raised rib on one side and can only be locked into the buckle assembly with the raised rib facing up. Ensure the harness straps are not twisted as they may become uncomfortable for the child.

Always apply the brakes before placing child in stroller seat. Position the shoulder strap near the child's shoulder and position crotch strap between legs.

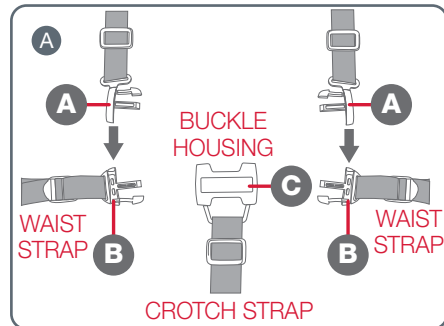

A Position the shoulder strap tongue (A) on top of the waist buckle tongue (B) on both sides.

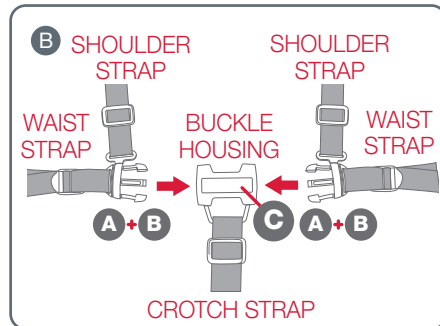

B Push both buckle tongues (A + B) into the buckle housing (C) until the buckle tongues lock into position.

⚠ WARNING

USE THE HARNESS AT ALL TIMES.

ADJUSTING THE HARNESS

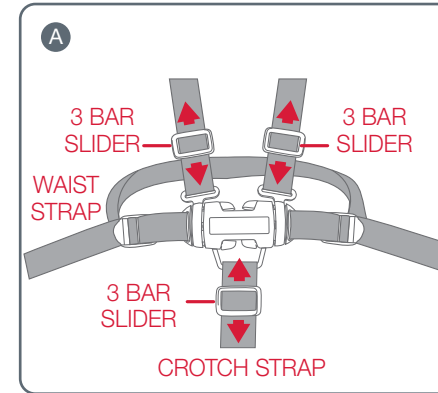

A Tighten or loosen the shoulder straps and crotch strap by sliding the 3 bar slider up or down. The crotch strap should be adjusted to a snug fit.

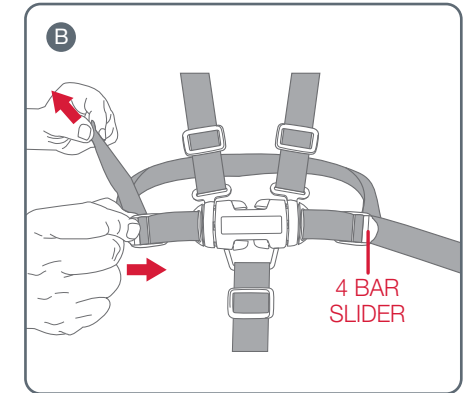

B Tighten or loosen the waist straps, hold and lift the 4 bar slider and pull the harness strap to adjust to the desired fit. The waist strap needs to fit firmly around the child.

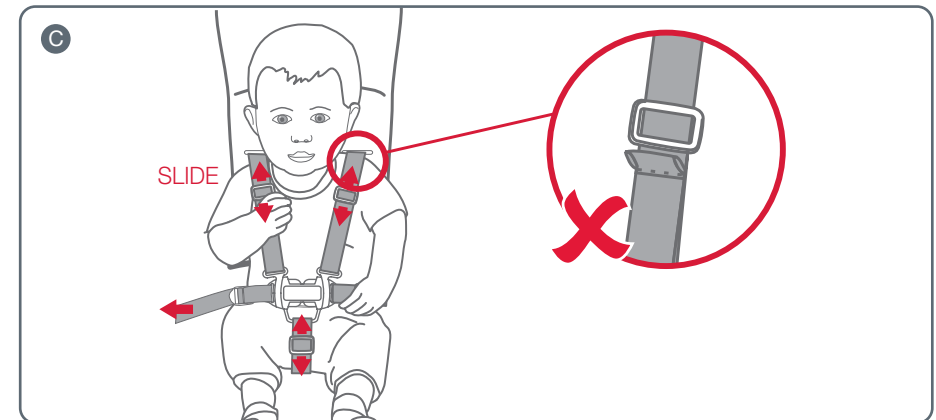

C To tighten or loosen the shoulder straps, slide the 3 bar slider up or down to adjust to the desired fit. Always adjust the harness strap when changing the seating position of the child.

⚠ WARNING

DO NOT SLIDE 3 BAR SLIDER OVER THE SEWN TAB ON SHOULDER HARNESS.

OPENING THE HARNESS

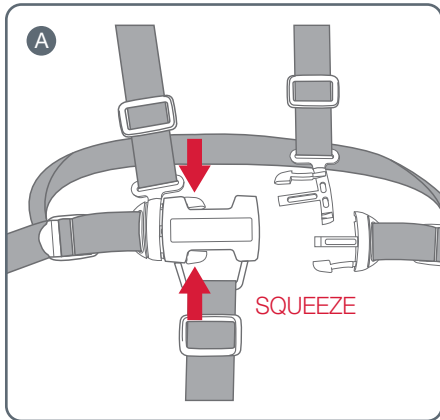

A To release the buckle, squeeze the top and bottom buckle tongues together with enough pressure so the buckle tongues can release from the buckle housing.

ADJUSTING THE SHOULDER HARNESS HEIGHT

IMPORTANT NOTE

The harness can be adjusted to three different heights to accommodate the child. The shoulder straps must be positioned near the child's shoulders.

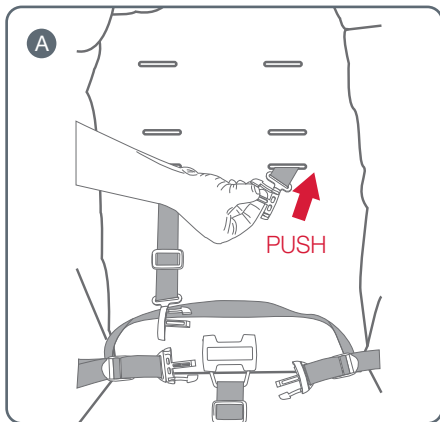

A To change the shoulder harness height, push the shoulder harness tongue out of the current harness slot and through the back of the seat.

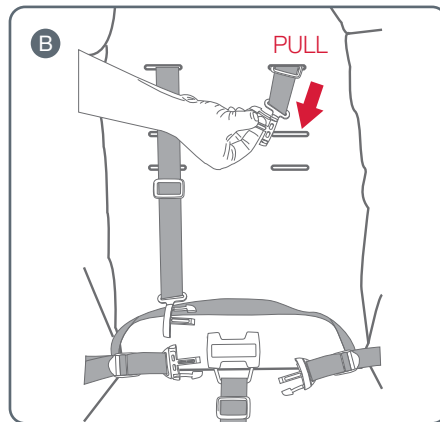

B Select the appropriate shoulder harness height and pull each shoulder harness tongue through the harness slot.

USING THE TETHER STRAP

⚠ WARNING

- THE STROLLER IS DESIGNED FOR USE ON FLAT OR GENTLY SLOPING SURFACES, AND MAY BE UNSTABLE ON HIGHER SLOPING AND UNEVEN SURFACES - USERS SHOULD BE AWARE OF THE POSSIBILITY OF THE STROLLER ROLLING AWAY OR TIPPING OVER.
- NEVER LET GO OF THE STROLLER WHEN PARKED ON AN INCLINE OR SLOPING SURFACE BECAUSE IT MAY SLIDE OR TIP OVER. ALWAYS PARK ON A FLAT SURFACE AND APPLY THE BRAKES.
- ALWAYS APPLY THE BRAKES WHENEVER THE STROLLER IS STATIONARY.

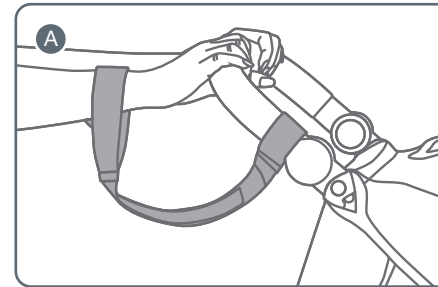

A A wrist tether strap is provided, place hand through the tether strap loop whenever you use the stroller. Only remove your hand from the tether strap loop when the brakes have been applied to the stroller wheels.

⚠ WARNING

USE THE TETHER STRAP TO STOP THE STROLLER ROLLING AWAY.

USING THE STROLLER

PLEASE REFER TO PAGE 6 FOR SMART LIFTING TECHNIQUES

IMPORTANT NOTES

- Always ensure you bend your knees where appropriate and take due care when lifting the frame.
- With your hand through the wrist tether strap loop, push the stroller holding the handle.
- The stroller can be steered in the desired direction - allowing the front wheels to swivel will make this easier.
- The front wheels may wobble or oscillate when walking fast, locking the front swivel wheels will stop this.
- The stroller can be taken up kerbs by either pressing down on the handles and raising the front wheels or turning the stroller around and pulling the stroller up the kerb.
- Caution is required when pushing the stroller on a steep slope as the stroller may become unstable. Always hold the handle firmly.
- Do not run with the stroller.
- Whenever you stop, always apply the brakes before you leave the stroller.
- Do not hang bags or goods unless it is supplied from the handle. Use the storage basket.

FOLDING THE STROLLER

PLEASE REFER TO PAGE 6 FOR SMART LIFTING TECHNIQUES.

IMPORTANT NOTES

- Remove the child from the stroller before commencing any folding operation.
- Fold the stroller slowly and be careful where you place your hands.
- When folding the stroller, be aware of the danger of being injured by moving parts and locking devices during the process. Keep all hands and limbs clear of these parts.
- There is potential for fingers or parts of the body to be injured when the stroller is being folded, due care should be exercised.
- Keep children clear of the stroller during folding the stroller.

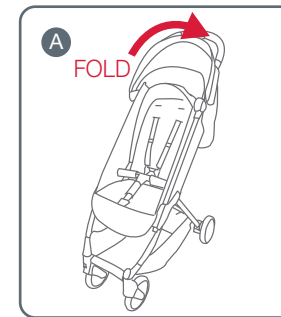

A Engage the brake and fold the canopy back. Empty out the basket.

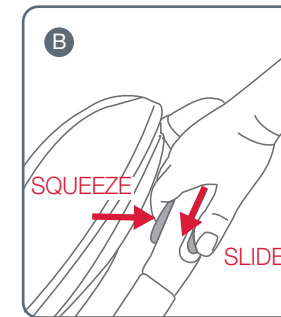

B Slide the button on the top of the handle to the left and squeeze the folding lever underneath the handle. At the same time.

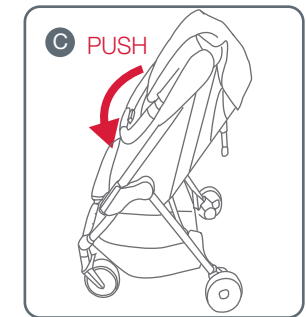

C Continue holding the lever and push the handle forward until handle is folded fully against the seat.

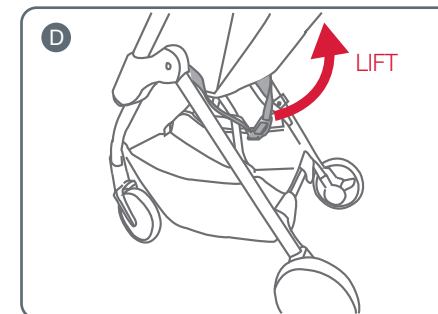

D Lift the carry strap upward quickly to fold the stroller.

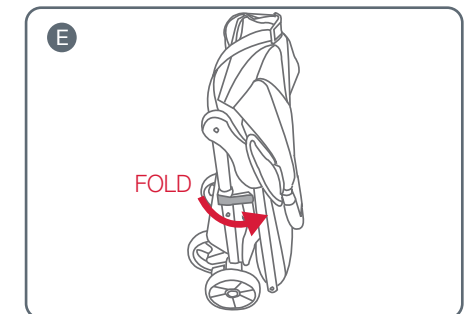

E Folding lock will be automatically engaged when the stroller is fully folded. Ensure the lock is engaged completely.

GENERAL MAINTENANCE & REPAIR

- To maintain the safety and longevity of the stroller, seek prompt repairs or replacement for bent, torn, worn, or broken parts. Do not continue to use the stroller if unsafe.
- All repairs should only be carried out by an authorised Safe-n-Sound® repairer. Only Safe-n-Sound® replacement parts should be used with the stroller. It may be unsafe to use parts supplied from another manufacturer.

GENERAL TIPS

Do not store the stroller in your car for prolonged periods of time during summer as it may lead to damage to some of the plastics components.

Do not leave the stroller in direct sunlight for extended periods of time, as colours of some fabrics may fade, and tyres may deteriorate.

Do not fold or store the stroller if damp or wet, as fabric may develop mould or mildew. Always store the stroller inside in a dry, well-ventilated area.

Do not place heavy objects on top of the stroller as it may alter the shape.

If there are compression marks on the tyres, use a domestic hair dryer to gently warm (DO NOT OVERHEAT) the tyre and the compression marks should slowly disappear.

Should you have any further questions on care & maintenance of the stroller, please contact our Consumer Service Team at:
aunz-support@britax.com

CLEANING

FABRICS

- Removable fabrics may be cleaned using lukewarm water and soap or mild detergent. Rinse thoroughly and allow to dry away from direct sunlight.
- Non-removable fabrics can be spot cleaned using a damp sponge and soap or mild detergent. Allow to dry completely before re-use or storage.
- Never use bleach, or abrasive cleaning products.
- DO NOT iron or dry clean.

NOTE: DO NOT place any of the stroller fabrics in the dryer. Allow to dry naturally, away from direct sunlight.

FRAME

- Remove dirt and dust away from any moving mechanism.
- Clean frame with a soft damp cloth and soap or mild detergent and allow to dry thoroughly.
- DO NOT use abrasive cleaning products as it may cause stains, discolouration or scratches to the frame.
- DO NOT soak or submerge frame in water.
- DO NOT remove, dismantle or alter any part of the stroller mechanism or brakes.

LEATHERETTE (IF APPLICABLE)

- Spot clean with a damp soft cloth.
- DO NOT use a dripping wet cloth or wet the leatherette excessively.

WHEELS

- Remove wheels from stroller.
- Clean with damp cloth and soap or mild detergent. Use brush to remove dirt and mud build up around the tyre. Allow to dry thoroughly before placing wheels back on the frame.
- If necessary lubricate wheel shaft with a small amount of lubricant before placing into the stroller.
- Ensure the stroller is cleaned thoroughly after using it on the beach as sand and salt can damage stroller mechanism, wheel assembly, causing premature wear and corrosion.

PLEASE NOTE

Our product warranty does not cover any rust to the rivets or screws, if you are caught in the rain or at the beach always thoroughly dry the frame to avoid any rust damage.

Just like servicing your car or bicycle, prams and strollers also need **regular maintenance checks**. These checks can improve product performance, extend the life of your stroller and help to provide you and your children a safe and smooth journey.



We recommend servicing your stroller every 6 months and completing an inspection once a month. To prolong the life of your stroller, a regular maintenance should be performed.

5 STEP CHECK LIST

- 1 INSPECT SAFETY DEVICES** tether strap, frame lock, harness, buckle and brakes, and ensure all are in working order and free from dirt, sand, and debris.
- 2 INSPECT** all connecting rivets and screws are secure.
- 3 MAKE SURE FOLDING JOINTS** are free of dirt, dust, and debris by cleaning with a damp cloth, allow to dry and lightly spray with a dry silicon lubricant. Please carefully read the lubricant instructions prior to use.
- 4 REMOVE WHEELS** and wipe clean with a damp cloth to remove any dirt, sand or debris. Allow to dry and lightly spray the wheel pivot pin with a dry silicon lubricant to keep the wheels moving smoothly. Please carefully read the lubricant instructions prior to use.
- 5 ENSURE WHEN FOLDING AND STORING** to wipe down your stroller frame and allow to dry before storing in a dry place without direct sunlight.

Did you know?

Registering your product online simplifies proof of purchase in the event of a warranty claim.

Head to our website to fill out the product registration form:

Australia: britax.com.au

New Zealand: britax.co.nz

MAKING A WARRANTY CLAIM

Your rights under a **Britax** company warranty are separate from and independent of your rights under the statutory consumer guarantees. What you need to do to enforce your rights under a statutory consumer guarantee is set out in the **Australian Competition and Consumer Commission's Consumer Guarantees - A Guide for Consumers**.

To make a claim under a Britax company warranty, please contact our customer service team on:

Australia: 1300 303 330

New Zealand: 0508 688 822

or alternatively by email at: aunz-support@britax.com

You will be required to:

- Return the product to the place of purchase or to a designated repair agent.
- Present your receipt as proof of purchase.
- Identify the defect in the product.
- Present the product to Britax for inspection on request.

Britax will advise you whether the product is covered by the **Britax** company warranty. **Britax's** decision of whether a product is covered by a **Britax** company warranty is final. **Britax** will act reasonably when determining whether a product is covered by a company warranty.

AUSTRALIAN CONSUMER LAW

On all of our goods, you have the benefit of a statutory consumer guarantee. In summary, goods are guaranteed to be of “acceptable quality” (fit for purpose), goods are guaranteed to match any sample against which they are sold. These consumer guarantees are provided for by the Australian Consumer Law and, if you believe any one of these guarantees is not satisfied by a Britax product, you have rights under the Australian Consumer law to enforce that guarantee.

Your rights under the statutory consumer guarantees are set out in the **Australian Competition and Consumer Commission’s Consumer Guarantees - A Guide for Consumers.**

In addition to the statutory consumer guarantees, **Britax** offers its own company warranty on all of its products. You therefore have the option of seeking redress for defective or faulty product either under the **Britax** company warranty or the statutory guarantees.

After the **Britax** company warranty expires, you still have your rights under the statutory consumer guarantees.

Depending on the product involved, the **Britax** company warranty on the following page applies:

Safe-n-Sound® WARRANTY

Safe-n-Sound® products are covered by this company warranty against faulty materials and workmanship (normal wear and tear excluded) that affects the normal operation of your **Safe-n-Sound®** product. In the unlikely event that you find that your **Safe-n-Sound®** product does not satisfy this warranty, **Britax** will (at its option) repair or replace that product within a reasonable period of you making a claim in accordance with this policy.

In the event that a replacement product is no longer available, **Britax** reserves the right to provide what it considers to be a suitable alternative.

For this company warranty to apply, you must make an application before the expiration of the following periods from date of purchase*.

This company warranty does not apply to second hand or after market goods or goods used for rental, hire or other commercial purposes or to any claim where the damage or fault is, in whole or part, the result of incorrect installation, mistreatment, intentional damage, any use other than use in normal conditions or any use otherwise than in accordance with the instruction manual for that product.

Please read your instruction manual carefully before using any of our products.

INTERNATIONAL WARRANTY

Britax products are available through a network of retailers in Australia and New Zealand. If you are an international customer we do not offer a warranty service outside of these regions.

THIS PRODUCT IS NOT INTENDED FOR COMMERCIAL USE

NOTES

In our constant pursuit of excellence we may alter this product and specification without notice.

This product may be covered by Australian and International patents and designs or pending applications. Safe-n-Sound® is a registered trademark and all Safe-n-Sound® model names are trademarks of Britax Childcare Pty Ltd.

This product is designed to comply with Australian Standard AS 2088:2022 "Prms and Strollers-Safety Requirements"

AUSTRALIA

Britax Childcare Pty. Ltd.

A.B.N 55 006 773 600

Head office and registered address:

Level 4, 650 Lorimer Street

Port Melbourne, VIC, 3207

P.O. Box 5119

Garden City, VIC, 3207

Customer Service: 1300 303 330

Email: aunz-support@britax.com

britax.com.au

NEW ZEALAND

Britax Childcare (NZ) Ltd.

Customer Service: 0508 688 822

britax.co.nz