



Convertible Child Seat

ISOFIX compatible

0_{YRS}

4_{YRS}

IMPORTANT:
KEEP THIS BOOKLET IN THE PLACE
PROVIDED ON THE CHILD RESTRAINT

Contents

Set Up

QUICK START GUIDE	
• REARWARD FACING SEATBELT	04
• REARWARD FACING ISOFLEX®	07
• FORWARD FACING SEATBELT	10
• FORWARD FACING ISOFLEX®	12
MEET YOUR CHILD SEAT	15
IMPORTANT INFORMATION AND WARNINGS	17
SHOULDER HEIGHT MARKERS	20
OUTGROWN YOUR CHILD SEAT	24
CHILD SEAT SUITABILITY GUIDE	25

Rearward Facing

CHILD SEAT FEATURES - REARWARD FACING SETUP	26
GENERAL INFORMATION	28
CONVERT TO REARWARD FACING	29
INSTALLING INTO YOUR VEHICLE	30
SEATBELT FOR REARWARD FACING	32
ISOFLEX® FOR REARWARD FACING	35
TOP TETHER FOR REARWARD FACING	37
HEADREST AND SHOULDER HARNESS	40
REMOVE CHILD FROM CHILD SEAT	43
REMOVE CHILD SEAT FROM VEHICLE SEATBELT	44
REMOVE CHILD SEAT FROM VEHICLE ISOFLEX®	46



REARWARD FACING
INSTALLATION VIDEO

Aircraft

HOW TO INSTALL IN AN AIRCRAFT	65
-------------------------------	----

Care and Maintenance

CARE AND MAINTENANCE	68
• CLEAN HARNESS BUCKLE	69
• REMOVE COVER	70
• REPLACE COVER	73
• ACCESSORIES	76
INSTALLATION OF VEHICLE UPPER ANCHOR POINT	79
IN CASE OF ACCIDENT	84
WARRANTY	88

Forward Facing

CHILD SEAT FEATURES - FORWARD FACING SETUP	48
GENERAL INFORMATION	50
FORWARD FACING RECLINE POSITIONS	51
INSTALLING INTO YOUR VEHICLE	52
SEATBELT FOR FORWARD FACING	53
ISOFLEX® FOR FORWARD FACING	55
TOP TETHER FOR FORWARD FACING	57
HEADREST AND SHOULDER HARNESS	59
REMOVE CHILD FROM CHILD SEAT	61
REMOVE CHILD SEAT FROM VEHICLE SEATBELT	62
REMOVE CHILD SEAT FROM VEHICLE ISOFLEX®	63



FORWARD FACING
INSTALLATION VIDEO

Hey! before you install me...

Don't forget to note your serial number found on the seat to complete your warranty registration.

<p>1.</p>	<p>2.</p>
<p>3.</p>	<p>4.</p>
<p>5.</p>	<p>6.</p> <p>Remove infant insert</p>
<p>7.</p>	<p>8.</p> <p>Lift up middle cover</p>

<p>9.</p>	<p>10.</p>
<p>11.</p> <p>NO TWISTS</p>	<p>12.</p> <p>Engage buckle</p>
<p>13.</p> <p>Fit firmly to car seat</p>	<p>14.</p> <p>Pull Push down</p> <p>REMOVE SLACK</p>
<p>15.</p> <p>Replace middle cover & infant insert</p>	<p>16.</p> <p>Lengthen Top Tether</p> <p>A Pull B Push</p>

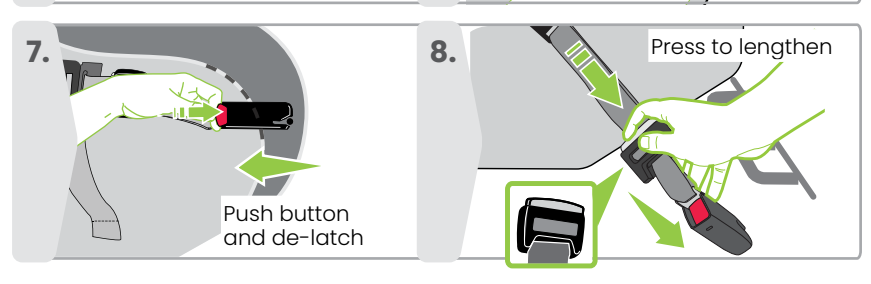
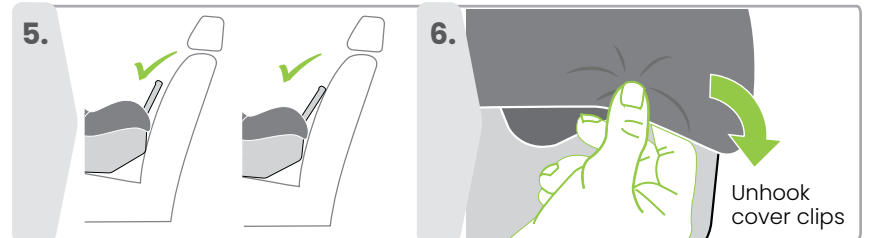
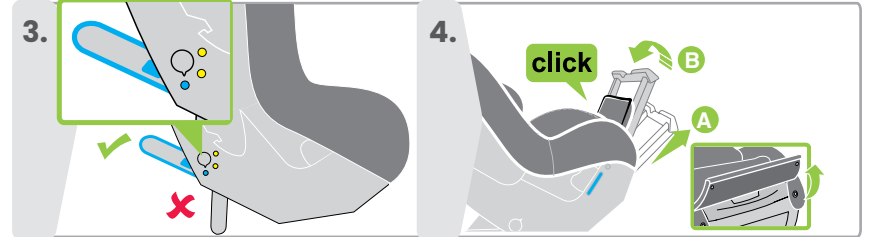
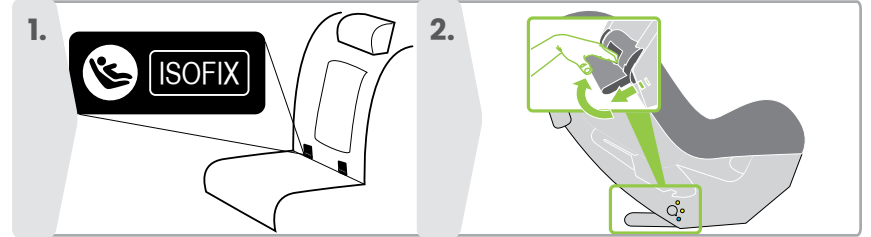
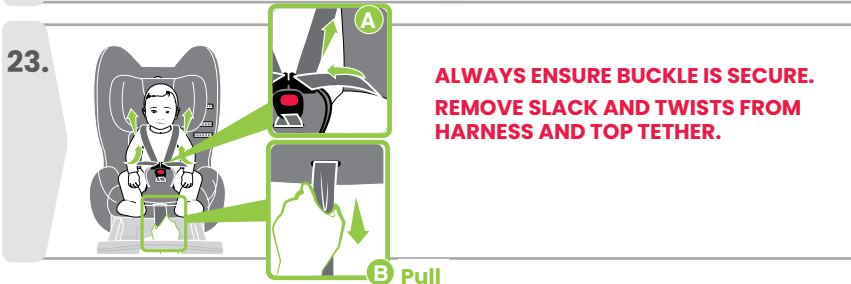
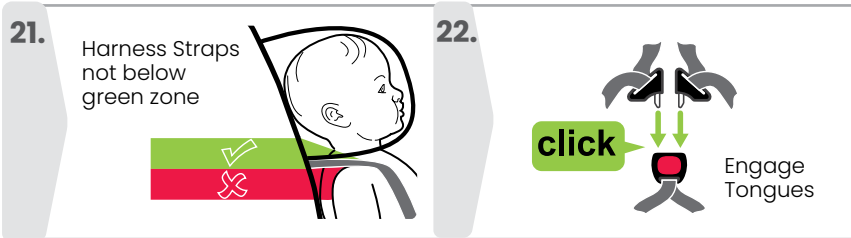
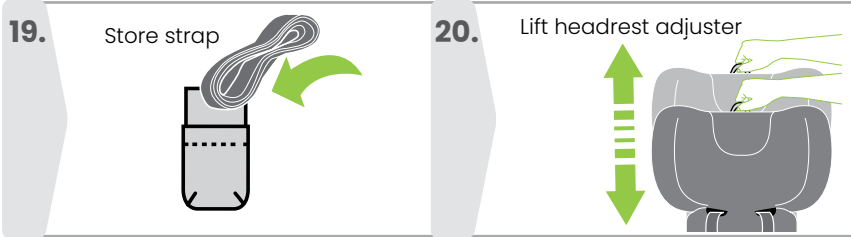
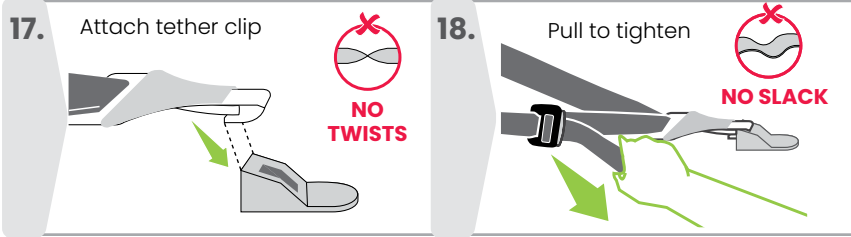

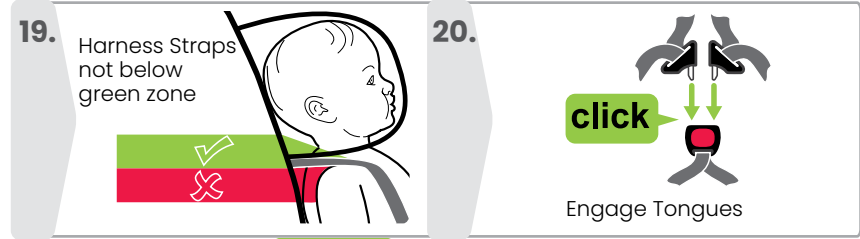
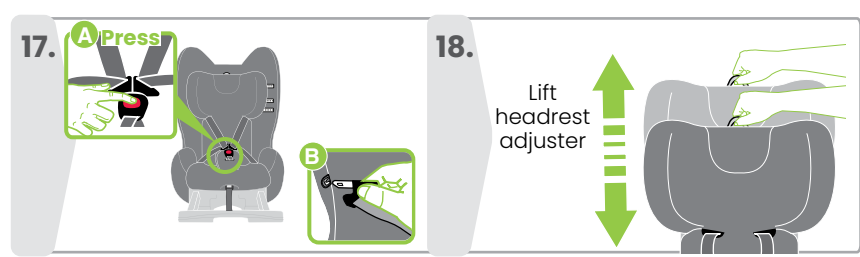
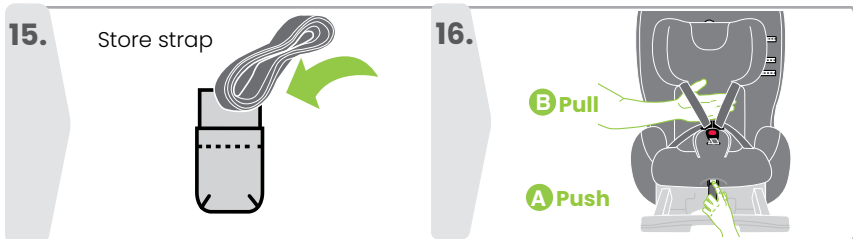
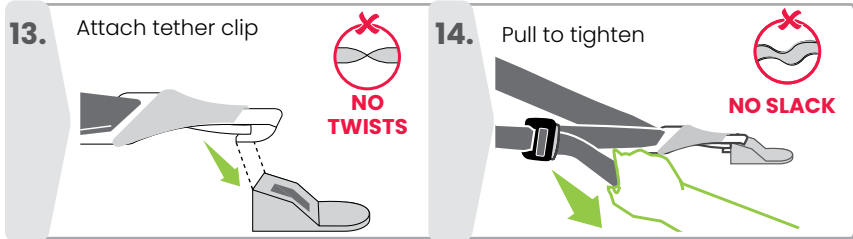
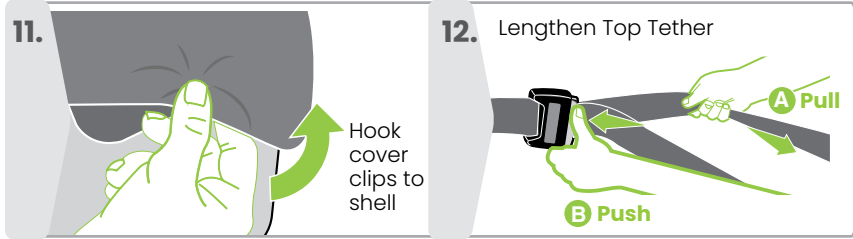
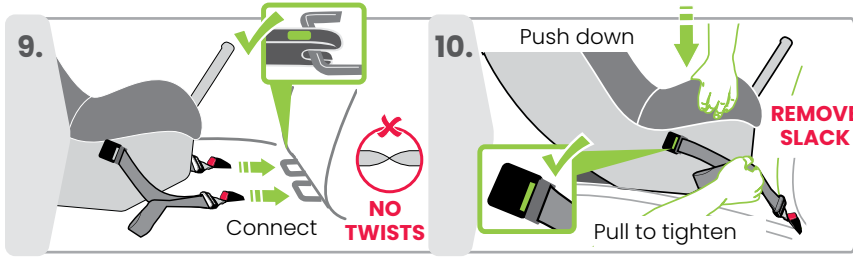

Hey!**before you install me...**

Don't forget to note your serial number found on the seat to complete your warranty registration.

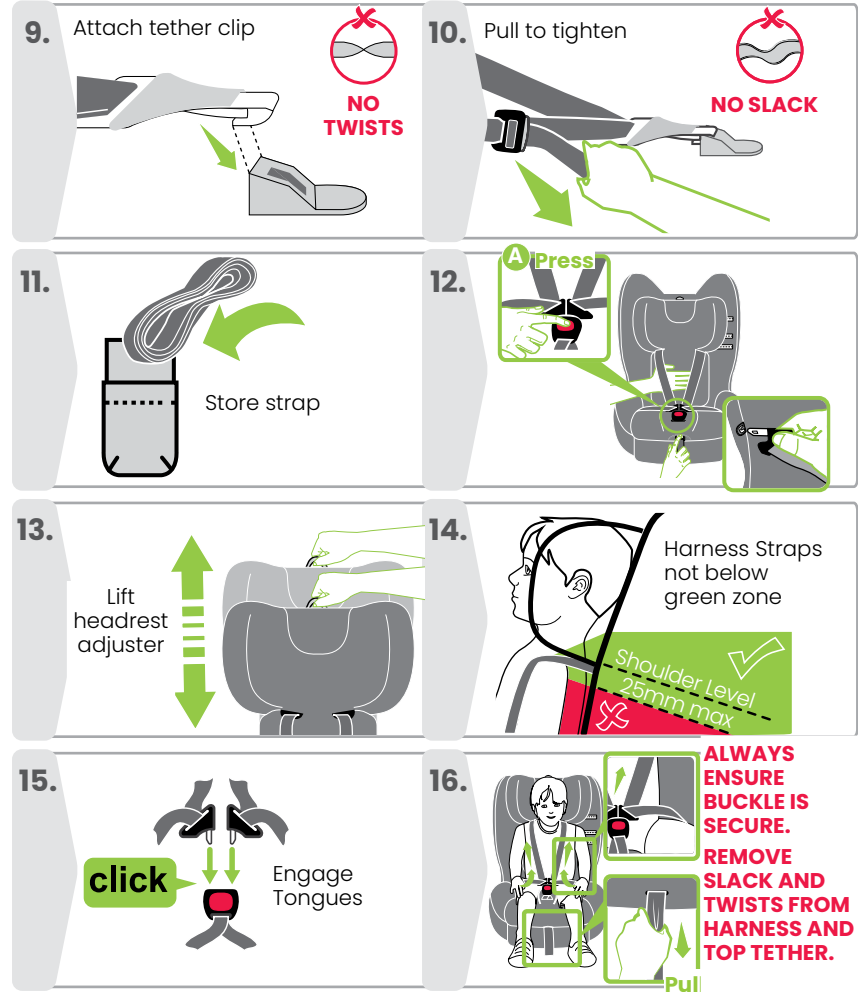
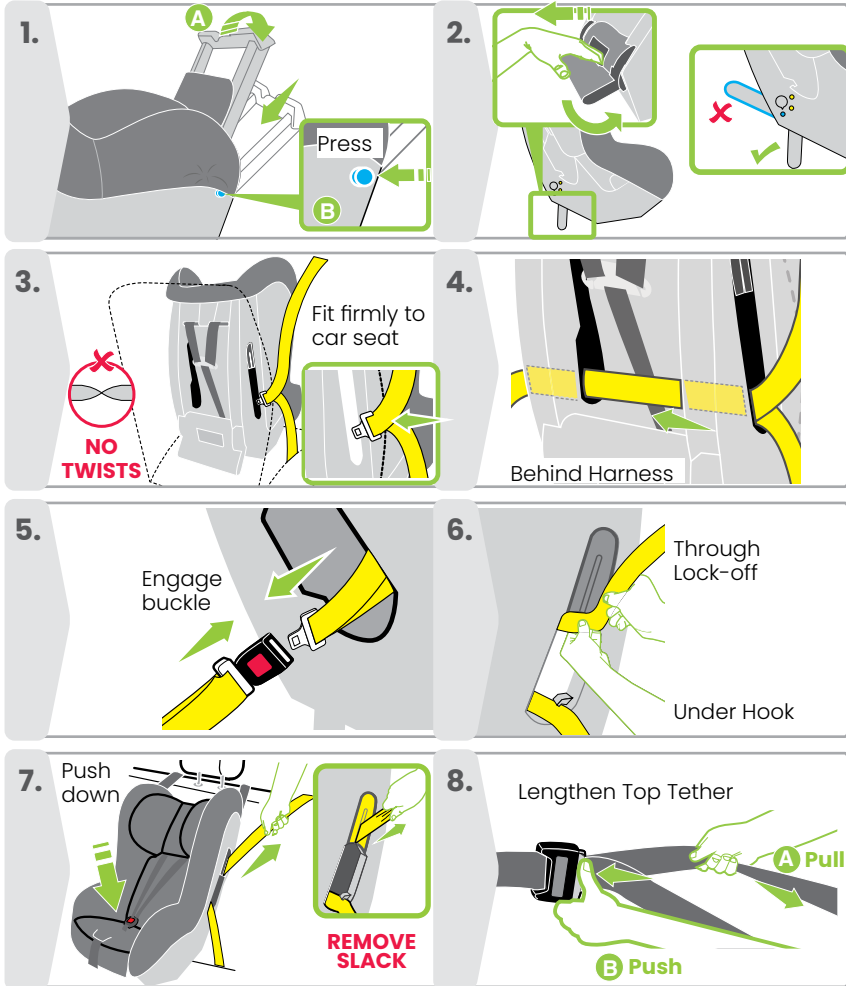

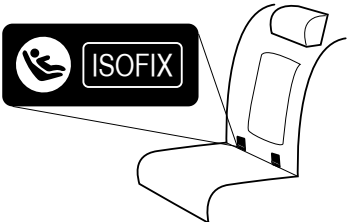
1.  ISOFIX

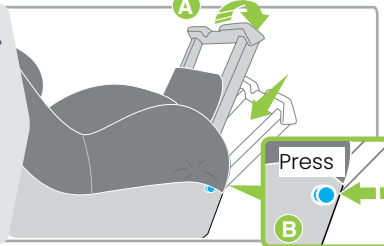
2.  **A**
Press
B

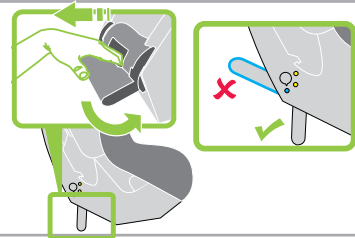
3. 

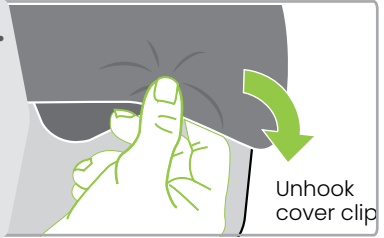
4.  Unhook cover clip

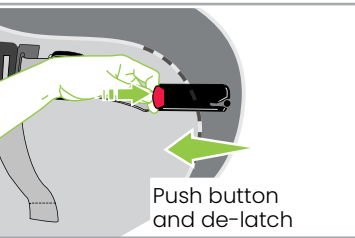
5.  Push button and de-latch

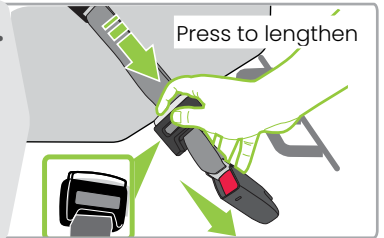
6.  Press to lengthen

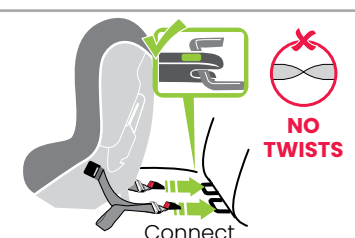
7.  **NO TWISTS**
Connect

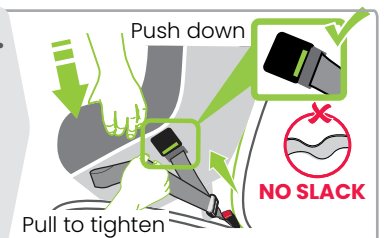
8.  Push down
Pull to tighten
NO SLACK

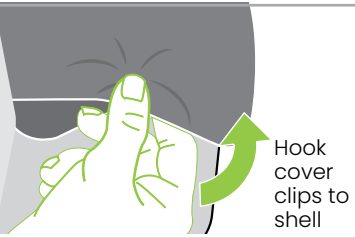
9.  Hook cover clips to shell

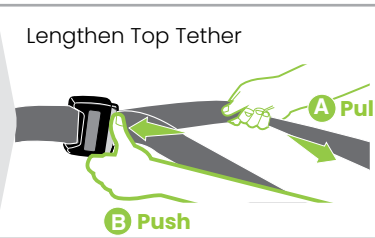
10. Lengthen Top Tether
 **A Pull**
B Push

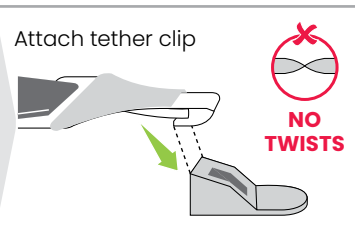
11. Attach tether clip
 **NO TWISTS**

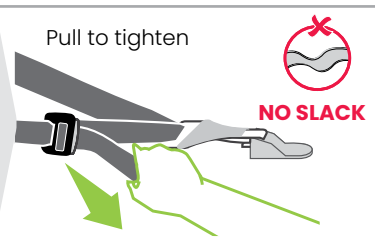
12. Pull to tighten
 **NO SLACK**

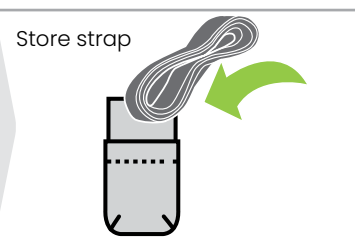
13. Store strap

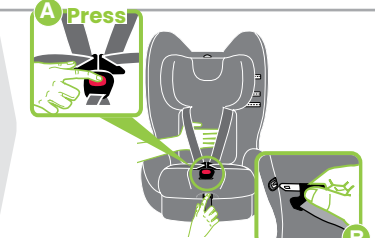
14.  **A Press**
B

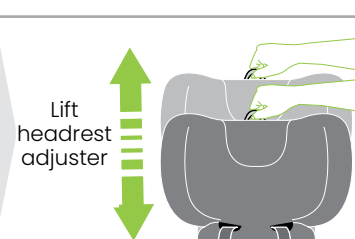
15. Lift headrest adjuster

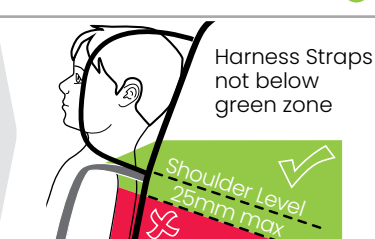
16.  Harness Straps not below green zone
Shoulder Level 25mm max

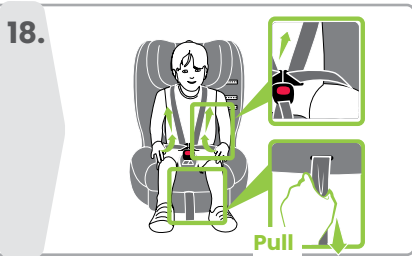

**ALWAYS ENSURE BUCKLE IS SECURE.
REMOVE SLACK AND TWISTS FROM
HARNES AND TOP TETHER.**

REARWARD FACING-

To be used only in a rearward facing position until the child's shoulders either reach the lower shoulder height marker (approximately 12 months of age) or reach the middle height marker (approximately 2 to 3 years of age).

FORWARD FACING-

Then to be used in a forward facing position until the child's shoulders reach the upper shoulder height marker (approximately 4 years of age).

Continue to use this child restraint until the child reaches this limit.

Do not use forward facing until child's shoulders are above the lower shoulder height marker.

Infants are at risk of serious injury if they face forward too early.

Children are at risk of serious injury if they move to booster seats too early.

Children who have outgrown this restraint are safest in a larger child restraint with an in-built harness or a booster seat until their shoulders reach the upper shoulder height marker of the restraint.

To ensure that your child gets all the protection designed into the restraint PLEASE READ AND FOLLOW THESE INSTRUCTIONS EXACTLY and use only Britax Safe-n-Sound® recommended parts and accessories.

If in doubt about the method of installation, consult Britax® Childcare or agent, or a child restraint fitter or, in New Zealand, to consult the agent for the vehicle.

只用于后向式安装，直到婴儿的肩膀达到靠下的肩高标记（大约12个月的宝宝）或者中部的肩高标记（大约2-3岁的儿童）。然后用于前向式安装，直到儿童的肩膀达到靠上的肩高标记（大约4岁的儿童）。在儿童达到该座椅上限以前必须不断使用这一安全座椅。

在儿童肩高未超过靠下的肩高标记之前不得采用前向式坐姿。

婴儿过早乘坐前向式座椅则可能受到严重的伤害。

儿童过早使用垫高椅则可能受到严重的伤害。

个子比该安全座椅大的儿童最安全的做法是乘坐设有内置安全带的更大汽车座椅或垫高椅，直到他们的肩膀达到该座椅靠上的肩高标记。

Chỉ được sử dụng ở vị trí hướng mặt về phía sau cho đến khi vai của bé cao tới vạch ghi ở dưới cùng (khoảng 12 tháng tuổi) hay tới vạch ghi độ cao ở giữa (khoảng 2 tuổi tới 3 tuổi). Sau đó được sử dụng hướng mặt về phía trước đến khi vai của em cao tới vạch ghi ở trên cùng (khoảng 4 tuổi).

Hãy tiếp tục sử dụng ghế em bé này đến khi em cao tới giới hạn này.

Không sử dụng hướng mặt về phía trước cho đến khi vai của em bé trên vạch ghi độ cao của vai ở dưới cùng. Bé sơ sinh có nguy cơ bị chấn thương nghiêm trọng nếu hướng mặt về phía trước quá sớm. Trẻ em có nguy cơ bị chấn thương nghiêm trọng đổi sang ghế em bé (booster) quá sớm.

Các em nào lớn hơn ghế em bé được an toàn nhất là trong ghế em bé (restraint) lớn hơn với đai nịt gắn sẵn hoặc ghế trẻ em rộng hơn cho đến khi vai của em cao tới vạch ghi độ cao của vai ở trên cùng của ghế em bé.

Meet Your Child Seat

ISOFIX COMPATIBLE

There will be straps fitted to each side of the lower part of the seat. Britax® flexible strap ISOFIX Compatible connector technology is known as ISOFLEX®.

WHAT ARE ISOFIX LOW ANCHORAGES IN A VEHICLE?

ISOFIX low anchorages are fixed, standardised anchoring points for securely installing an ISOFIX compatible child restraint in a vehicle fitted with ISOFIX low anchorages. They are an alternative method of installing the child restraint without using the car's seatbelt.

ISOFIX is an international standard for vehicle child seat anchorages.

This anchoring technology minimises installation mistakes by optimising the protective effect of the connection between vehicle and ISOFIX compatible child restraint.

Side Impact Cushion Technology™ (SICT)

Side Impact Cushion Technology™ (SICT) (if supplied) may be fitted on this seat. There is no installation or assembly required to activate the Side Impact Cushion, it functions in a side crash to provide additional protection to the occupant.

WARNINGS

- Fit the restraint firmly to the car seat.
- Fit the harness firmly to the child.
- A loose restraint or harness is dangerous.
- Supervision of children is needed because they may be able to undo the buckles and adjusters.
- Use the restraint exactly as shown in the instructions.
- DO NOT LEAVE CHILDREN UNATTENDED IN THE CAR.
- Do not alter or modify this restraint.
- Repairs must only be done by the manufacturer or agent.
- Do not allow the restraint to come into contact with polishes, oils, bleach and other chemicals.
- Destroy the restraint if it has been in a severe crash, even if no damage is visible. See page 84 & 85.
- DO NOT USE THIS RESTRAINT WITHOUT THE COVER.
- Always secure the loose end of the top tether strap. Do not use the child restraint where this top tether strap may fall into a split in the seat back or off the side of the seat.
- ALWAYS ATTACH TOP TETHER HOOK AND REMOVE SLACK.
- To ensure infant's back is evenly supported, do not put more than one nappy on the baby and make sure the nappy is not thickly folded at the back.
- DO NOT USE A REAR FACING CHILD RESTRAINT WHERE AN AIRBAG IS FITTED IN FRONT OF THE SEATING POSITION.
- Do not harness an infant wrapped in a blanket or swaddled. Any blanket or wrap must only be placed over the harness and infant.
- Rearward and forward facing child restraints should always be correctly installed, properly adjusted and used as instructed by the manufacturer instructions.
- If your vehicle is not fitted with an anchor point, please contact a Safety Restraint Fitting Station authorised by the relevant State Government Body for correct fitment of the restraint. In New Zealand contact the agent for the vehicle. The top tether strap must be attached to an upper anchorage point using an extension strap if necessary.
- Do not use on any vehicle seat which faces sideways or rearwards.

 **IMPORTANT:**

TO BE USED WITH A LAP-SASH OR LAP-ONLY SEATBELT OR ISOFIX LOW ANCHORAGES IN THE BACK OF MOST CARS WITH FORWARD FACING SEATS.

GENERAL

- Do not attach the lower attachment connectors of two separate child restraints to the same ISOFIX low anchorages in your car.
- Always attach the top tether strap to the child restraint upper anchorage in your car.
- Child restraint lower attachment connectors and the ISOFIX low anchorages in your car are designed to withstand only those loads imposed by a correctly fitted child restraint.
- Babies and children below 4 years old must not sit in the front seat of a vehicle unless allowable by the Regional Road Rules. Check your Regional Road Rules.
- Protect all webbing from abrasion and cutting by sharp corners and edges.
- The restraint should not be purchased or sold as a second hand item. It is recommended not to use child restraints older than 10 years as the protection in an accident may be reduced.

GENERAL

- THIS RESTRAINT IS NOT SUITABLE FOR USE WHERE THE TOP TETHER STRAP MAY FALL INTO A SPLIT IN THE SEAT BACK OR OFF THE SIDE OF THE SEAT.
- Seatbelt extenders are not recommended to be used if the seatbelt is not long enough to secure the child restraint. If seatbelts are too short then seek advice from a child restraint fitter and consider their recommendations before using a seatbelt extender. If you use a seatbelt extender then ensure that the seatbelt buckle does not enter the rearward or forward facing belt paths.
- Ensure babies and toddlers are adequately shaded from direct sunlight through side or rear windows.
- Check the car is ventilated by opening windows or using the car's ventilation system taking in external air. Recirculation setting is not suitable for providing ventilation.
- THIS RESTRAINT MUST BE ATTACHED TO A CHILD RESTRAINT UPPER ANCHORAGE POINT IN THE CAR. REFER TO CAR OWNER'S HANDBOOK FOR LOCATION OF UPPER ANCHORAGE POINTS. REFER TO A CHILD RESTRAINT FITTING STATION IF NO UPPER ANCHORAGE POINTS ARE IN THE MOTOR CAR. Refer to pages 79 to 83.

Shoulder height markers are featured clearly on the child seat (as seen in diagram). The markers provide an indicator for when your child has outgrown the child's seat rearward or forward facing modes.

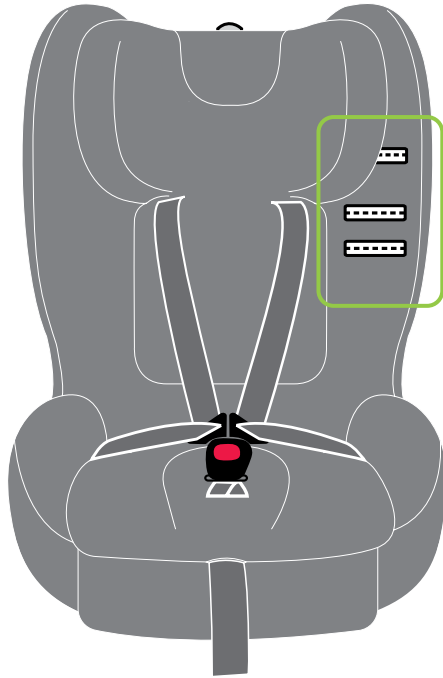

Upper Height Marker	<p>SHOULDERS MUST BE BELOW THIS LINE</p>	<p>If your child's shoulders are above the upper marker they have outgrown the seat (see page 24).</p>
Middle Height Marker	<p>MUST BE FORWARD FACING WHEN SHOULDERS ABOVE THIS LINE</p>	<p>Your child MUST be forward facing if their shoulders are above the middle marker.</p>
Lower Height Marker	<p>MUST BE REAR FACING WHEN SHOULDERS BELOW THIS LINE</p>	<p>Your child MUST be rearward facing if their shoulders are below lower marker.</p>

Britax* recommends using this restraint in rearward facing as long as possible.

! IMPORTANT: Follow this advice.

SHOULDERS MUST BE BELOW THIS LINE



MUST BE FORWARD FACING WHEN SHOULDERS ABOVE THIS LINE



MUST BE REAR FACING WHEN SHOULDERS BELOW THIS LINE



Child Use (Forward Facing)



Upper Height Marker
Middle Height Marker

Older Baby (Rearward Facing)



Middle Height Marker
Lower Height Marker

Older Baby (Forward Facing)

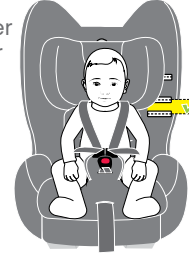

Middle Height Marker
Lower Height Marker

OR

Newborn (Rearward Facing)



Lower Height Marker

When your child has outgrown this seat, you can use:



- A harnessed child seat with in-built harness suitable for children **approximately 6 months to 8 years old**.

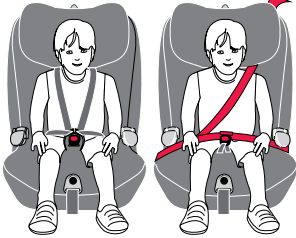

- A convertible booster seat with in-built harness until **approximately 4 years old** and then as a booster seat with vehicle lap-sash seatbelt until **approx 6 to 8 years of age** (or seatbelt and compatible child harness).



- Or a dedicated booster seat with vehicle lap-sash seatbelt until **6 to 8 years of age or until 8 to 10 years of age** (or seatbelt and compatible child harness).

These child restraints, when used correctly, allow the driver to meet the Australian Road Rules in each state.

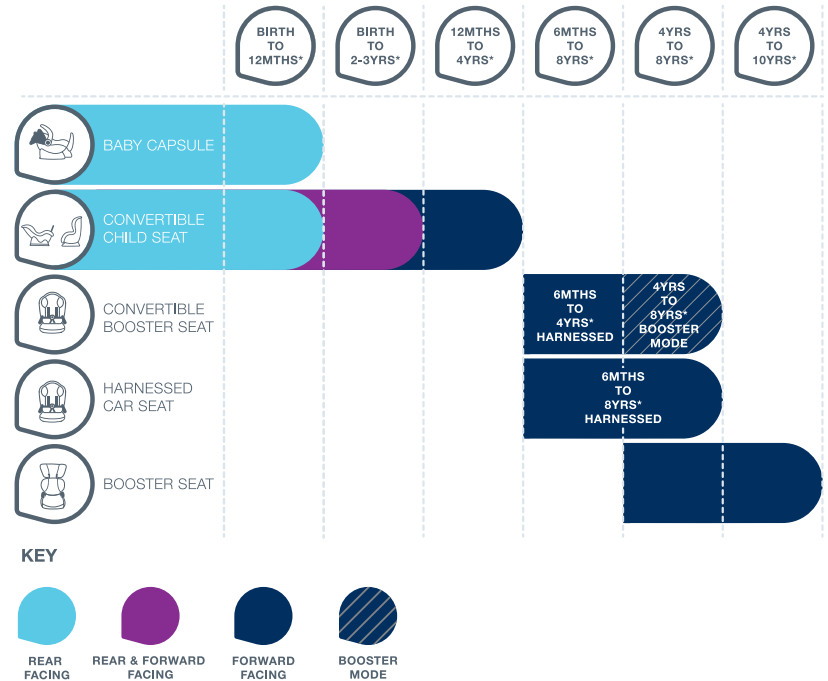

* Ages are an approximation. Refer to the shoulder height markers for progression to forward facing mode or graduation to next restraint.

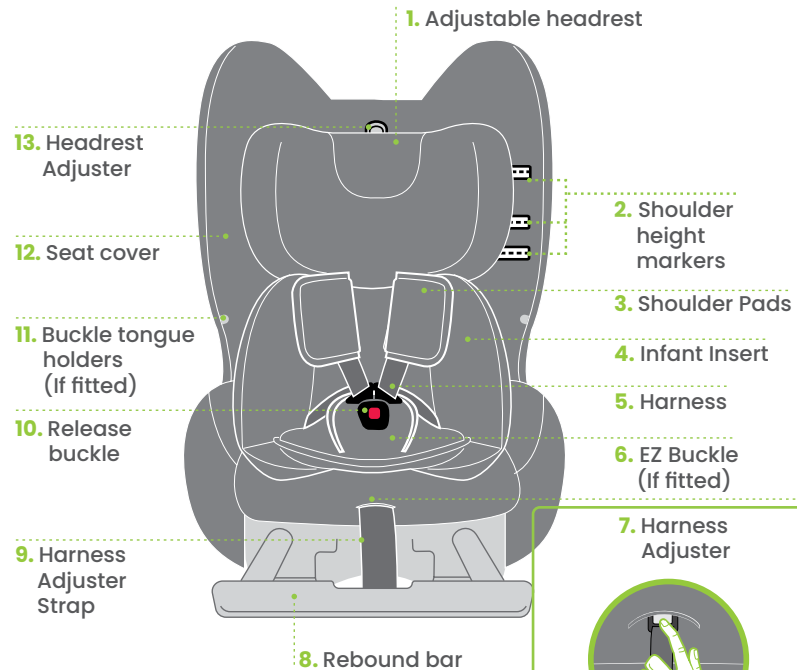

Harness adjuster located under cover

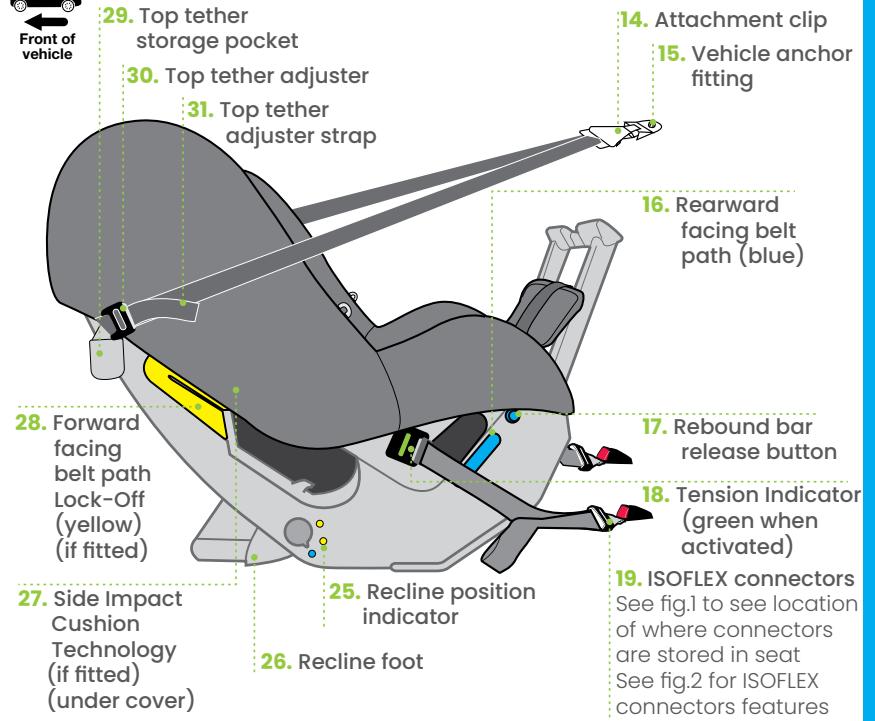

Fig.1

ISOFLEX® Connectors are stored on each side under the seat cover.

Fig.2

Set up – General information for Rearward Facing

Child seat upper anchorage point

This child seat must be installed using the top tether. The top tether will need to attach to the appropriate upper anchorage point for both rearward and forward facing modes. Refer to the car owner's handbook for anchorage locations or points. If your vehicle does not have an upper anchorage point then you will need to install an upper anchorage point. Refer to pages 79 to 83.

Is there enough room?

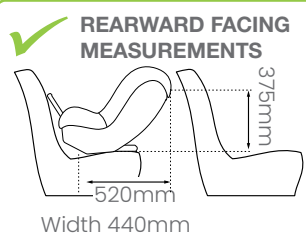

To ensure that the space is sufficient, the purchaser should check the measurements between the vehicle's rear and front seats in which the child restraint is intended to be used for both rear facing mode and forward facing mode.



Do not allow the front seat to alter the installed angle of the restraint.

⚠ WARNINGS

DO NOT USE RESTRAINT IN REARWARD FACING MODE WITHOUT THE REBOUND BAR FULLY EXTENDED.

Do not use the restraint without the top tether strap correctly attached.

Do not use on any vehicle seat which faces sideways or rearwards.

A rear facing child restraint should not be used in the front seat if a passenger airbag is fitted and cannot be disabled.

Set up – Convert to Rearward Facing

1.

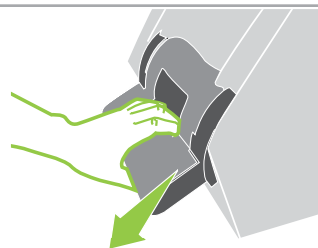

Move recline foot by pulling the recline foot handle and rotating to the rearward facing position until the foot locks into position.

2.

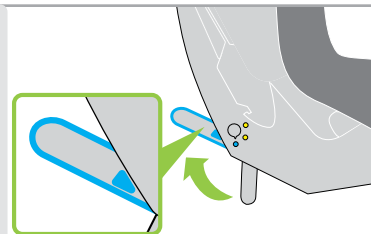

Check the blue segment on the recline foot label is fully visible, to ensure the seat is in rearward facing mode.

⚠ IMPORTANT:
Rebound bar must be used in rearward facing mode.

3.

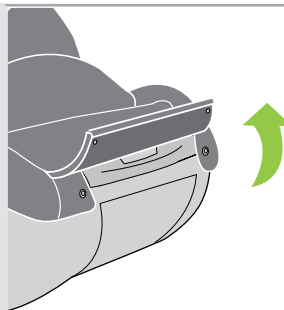

Unbutton the front flap to expose the rebound bar.

4.

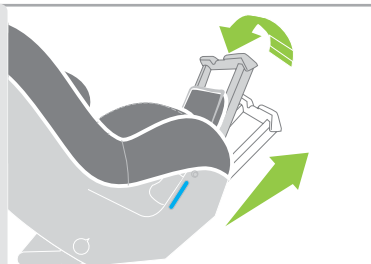

Fully extend the rebound bar out towards you and then lift upwards to lock into place.

Set Up - Installing Into Your Vehicle For Rearward Facing

5.

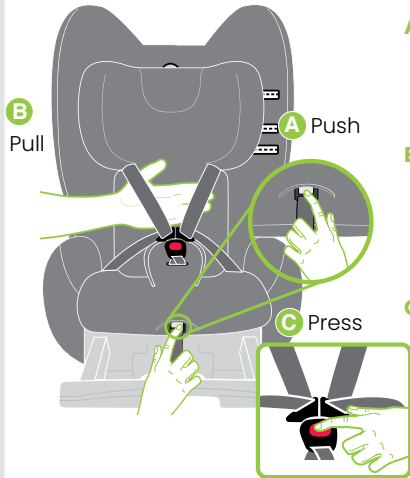

- A.** Push the harness adjuster located under the trim.
- B.** Place your hand under both shoulder harness straps, then pull shoulder harness straps to lengthen.
- C.** Disengage buckle by pressing the red button. Remove infant insert (if fitted).

7.

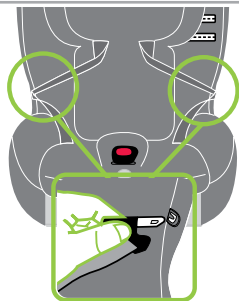

Place buckle tongues into buckle tongue holders.

8.

Position In Your Vehicle

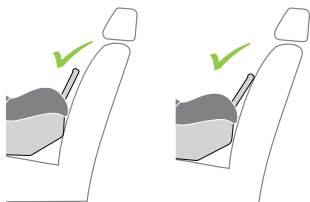

Choose your vehicle seat position for rearward facing mode. Ensure child seat is against vehicle seatback - the rebound bar does not need to contact vehicle seatback. If desired, this gap may be packed (see page 31).

Set Up - Installing Into Your Vehicle For Rearward Facing

9.

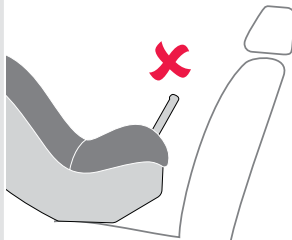

Do not have the seat too far away from the vehicle seat.

10.

Top tether behind the child seat

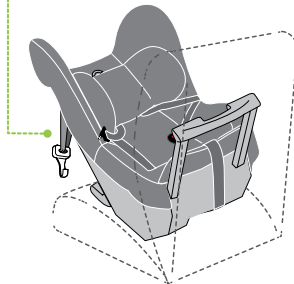

Allow top tether and clip to hang down from child seat until it is installed later.

11.

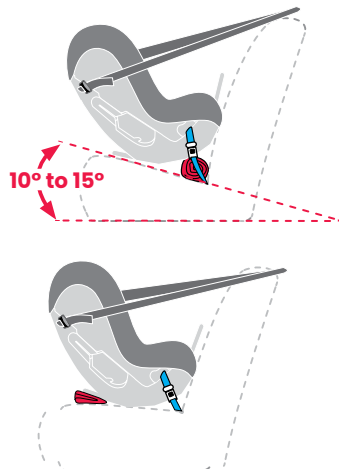

Angular Adjustment Of Child Seat

Some vehicle seats have more rearward slope than others. The angle may be adjusted by placing a firm packing between the seat and the underside of the base. Packing can be a firmly rolled up towel.

If the vehicle seat is flat then some packing may be required at the front edge of the base to achieve the recline angle.

Do not remove all of the rearward slope by over packing. Always leave a rearward slope angle of approximately 10 to 15 degrees as shown

32 Set Up – Seatbelt For Rearward Facing

Please ensure you have followed the steps on pages 28 – 31

1.

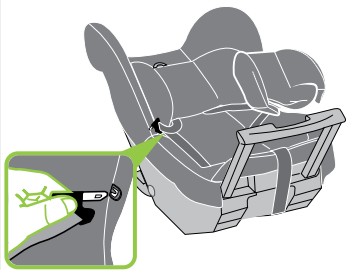

Remove infant insert (if fitted).
IMPORTANT - Ensure buckle tongues are placed into buckle tongue holders prior to feeding through seatbelt.

2.

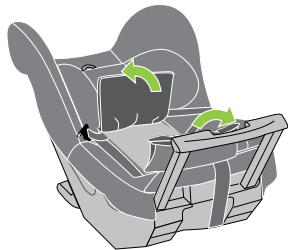

Lift out middle cover.

3.

Vehicle Seatbelt

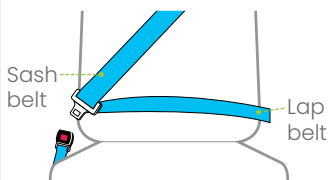

Lengthen vehicle seatbelt.

4.

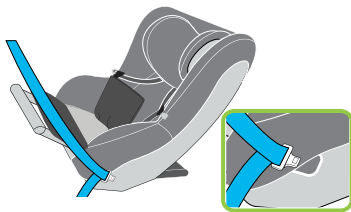

Feed vehicle seatbelt through blue REARWARD FACING BELT PATH guide.

Set Up – Seatbelt For Rearward Facing 33

5.

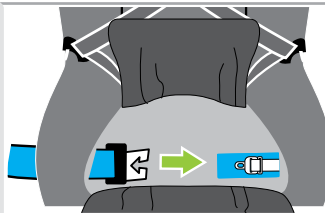

Continue feeding vehicle seatbelt through opposite blue REARWARD FACING BELT PATH guide.

6.

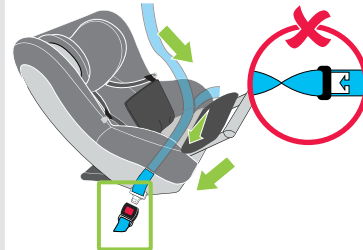

Engage the vehicle seatbelt buckle and tongue without twists.

7.

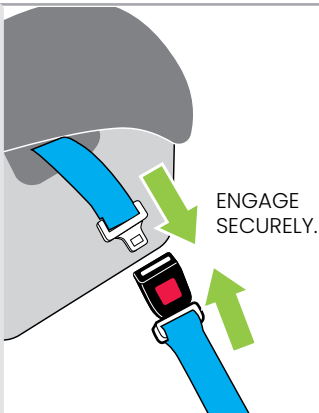

ENSURE THERE ARE NO TWISTS IN SEATBELT.

NOTE: Seatbelt extenders should not be used if the seatbelt is not long enough to secure the child restraint. If they are used then the buckle must not enter the seating zone.

7.

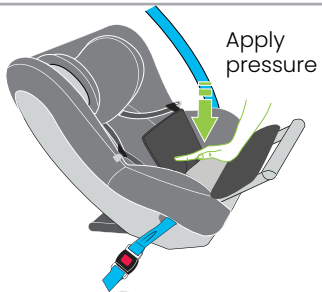

Now apply downward pressure onto the inner seat and remove all the seat belt slack by pulling the seat belt from the buckle side across the child seat and back into the retractor.

ALWAYS REMOVE SLACK FROM SEATBELT.

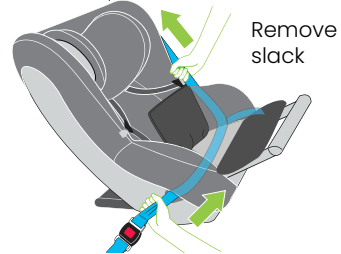

ENSURE THERE ARE NO TWISTS IN SEATBELT.

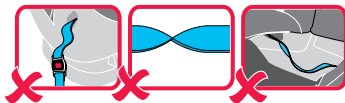

8.

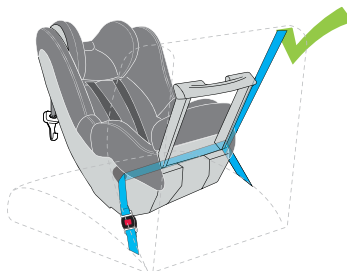

Refit middle cover and infant insert as required.
You have now successfully completed the seat belt installation and are now ready to install the top tether.

Please go to page 37.

You do not need to ISOFLEX® install with seatbelt.

A LOOSE INSTALLATION IS DANGEROUS.

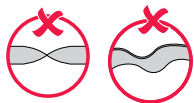

Please ensure you have followed the steps on pages 28 – 31

1.

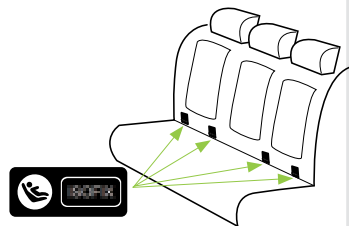

Locate the ISOFIX Low Anchorage in the vehicle rear seat. If you cannot locate the ISOFIX anchorages, check your vehicle owners manual.

2.

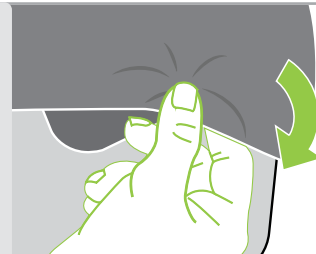

Unhook the clip from the cover to reveal the ISOFLEX® connectors

3.

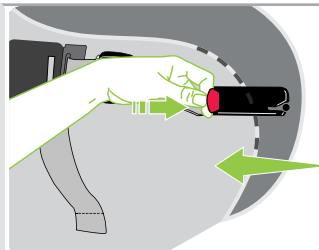

Release both ISOFLEX® connectors on each side of the restraint, by pressing the red button on the connectors.

4.

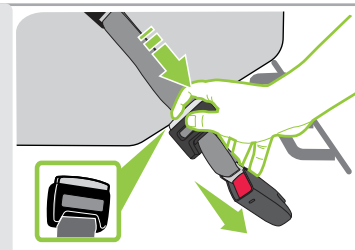

Press and hold the ISOFLEX® adjuster release button and pull the connector strap to fully lengthen. Repeat for the other connector.

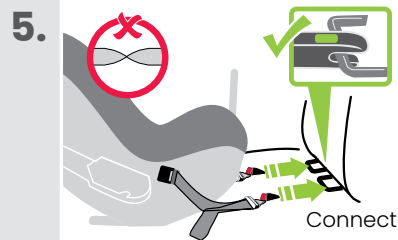

Connect the ISOFLEX® connectors. Give a firm tug on the connector to check it is securely fitted. Connectors may also show a green indicator on top.

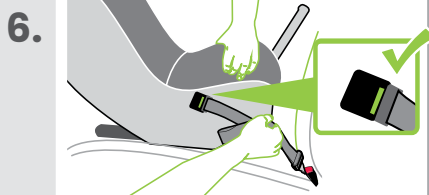

With the child seat in position, apply firm pressure whilst pulling on adjuster strap to remove all slack and tighten the ISOFLEX® strap. Repeat on the other side of the restraint. The two tension indicators will show green indicating minimum tension has been applied.

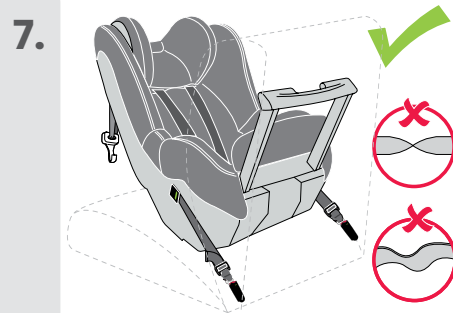

You have now successfully completed the ISOFLEX® installation and are now ready to install the top tether. Please go to page 37. You do not need to seatbelt install with ISOFLEX®.

ENSURE THERE ARE NO TWISTS IN ISOFLEX® CONNECTOR STRAPS.
ALWAYS REMOVE SLACK FROM ISOFLEX® STRAPS.
A LOOSE INSTALLATION IS DANGEROUS.

⚠ IMPORTANT:

Do not attach the lower attachment connectors of two separate child restraints to the same ISOFIX low anchorages in your car. Always attach the top tether strap to the child restraint upper anchorage in your car.

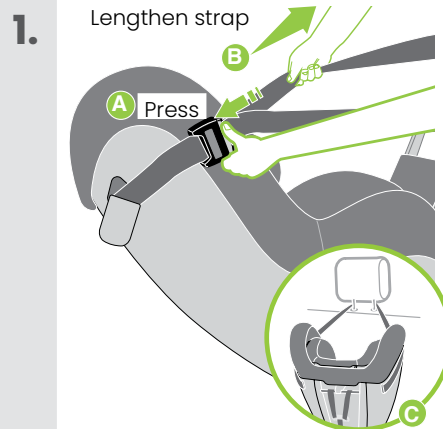

- A. Press top tether adjuster button.
- B. Lengthen top tether strap fully, ensure all unnecessary twists are removed.
- C. Place the top tether over the vehicle seatback, and if needed, remove the vehicle headrest. If you cannot remove the headrest, then ensure that the top tether straps are placed on the outer-sides of the headrest.

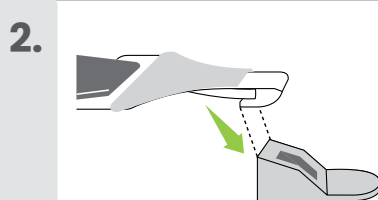

Connect top tether attachment clip to vehicle anchor fitting. Check your vehicle manual for the correct anchor fittings in your vehicle.

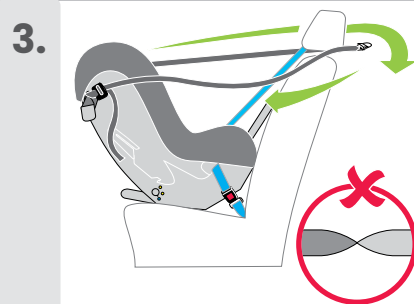

Pull top tether strap slack onto side of adjuster.

ENSURE THE TOP TETHER STRAPS ARE NOT TWISTED TIGHTLY. A HALF TWIST IS ACCEPTABLE.

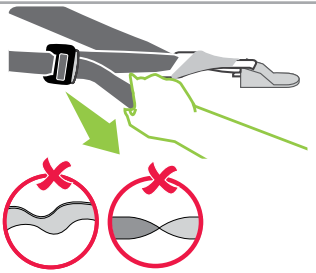
4. 

Ensure slack is removed from the top tether straps by pulling top tether adjuster strap. Do not over tighten as it may cause your child seat to lift.

ALWAYS REMOVE SLACK IN THE TOP TETHER AND STORE STRAP.
ENSURE THE TOP TETHER STRAPS ARE NOT TWISTED.

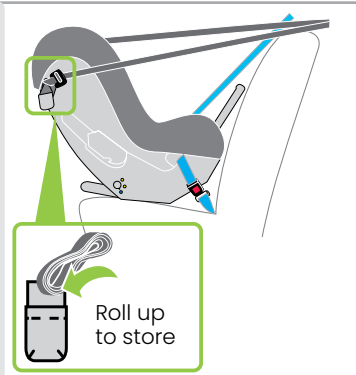
5. 

Check angle of child seat is still correct. (See page 30). Roll up any excess strap and store in the pocket provided on the top tether strap.

⚠ CAUTION:
CHILDREN CAN BE INJURED OR RESTRAINTS AND TOP TETHER STRAP DAMAGED BY UNSECURED CARGO IN A COLLISION. SECURE OR REMOVE HAZARDOUS CARGO BEFORE USING THIS CHILD RESTRAINT.

⚠ IMPORTANT:

The top tether strap must be fitted at all times. Always secure the loose end of the top tether strap to prevent it hanging out of the car or being accessible by the child.

ALWAYS ATTACH TOP TETHER HOOK AND REMOVE SLACK IN THE TOP TETHER STRAP.

Take care to avoid contact with sharp objects which may damage the Top Tether webbing (e.g. Vehicle Headrest poles and pole guides). Remove vehicle headrest if necessary (Refer Vehicle Instruction Manual)

Do not attach the top tether of two separate child restraints to the same vehicle anchorage.

Set Up – Headrest And Shoulder Harness For Rearward Facing

1.

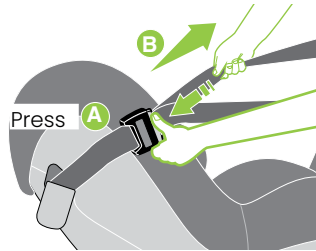

- A. Press top tether adjuster button and
- B. Lengthen top tether strap fully (if desired).

2.

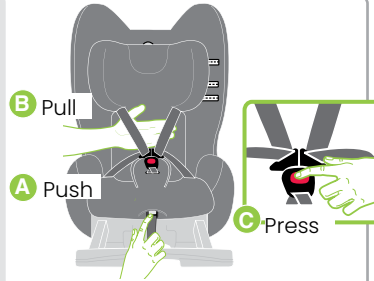

- A. Push harness adjuster (located under trim.)
- B. Place your hand under both shoulder harness straps, then pull shoulder harness straps to lengthen.
- C. Disengage the buckle by pressing the red button.

3.

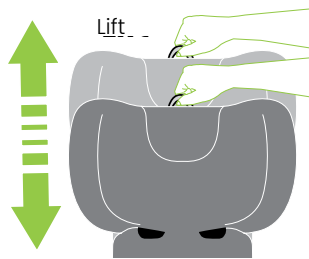

Lift lever to adjust headrest/
harness slots.

4.

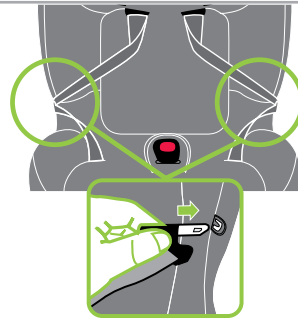

Place buckle tongues into
buckle tongue holders.

5.

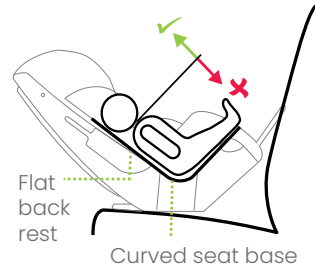

Place baby into the child seat. Ensure your baby is positioned with their back flat against the back rest and their bottom correctly positioned into the curved seat base.

6.

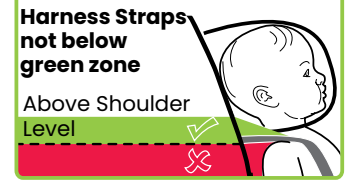

Check the headrest and shoulder slot position is level with the shoulders but not below. The shoulder straps must be in the slots which are nearest to the child's shoulders but not lower than the child's shoulders. **Always adjust the height of the shoulder straps as the child grows.**

7.

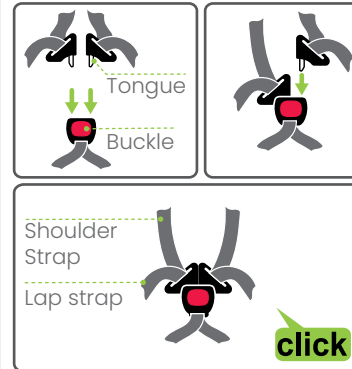

Engage Buckle.

ENSURE BUCKLE IS ALWAYS CONNECTED DURING USE.
ENSURE ALL HARNESS STRAPS ARE NOT TWISTED.

Set Up – Headrest And Shoulder Harness For Rearward Facing

Set Up – Headrest And Shoulder Harness For Rearward Facing

8.

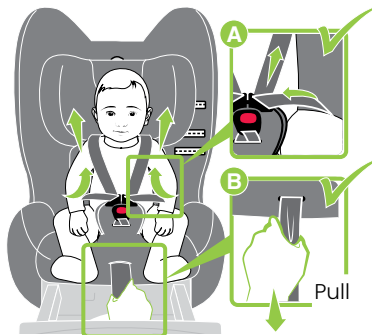

A. Remove all slack from the lap strap area (including behind baby's bottom), by pulling up on the shoulder straps.

B. Pull harness adjuster strap to tighten. Ensure a firm but comfortable fit.

REMOVE ALL HARNESS SLACK

Remove slack from the top tether straps by pulling the top tether adjuster strap.



WARNING:

DO NOT LEAVE CHILDREN UNATTENDED IN THE CAR.

Do not harness an infant wrapped in a blanket or swaddled as this increases the risk of ejection and injury or death in a crash. The harness needs to fit firmly to the baby, any blanket or other covering may be placed over the harness after it is adjusted. Arms and legs must be free and not bound or wrapped together. The legs must sit on each side of the crotch strap.

Set Up – Remove Child From Child Seat For Rearward Facing

1.

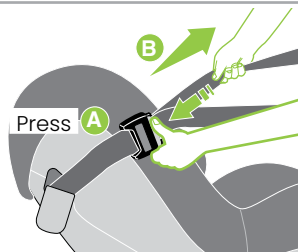

- A.** Press top tether adjuster button and
- B.** Lengthen top tether strap fully.

2.

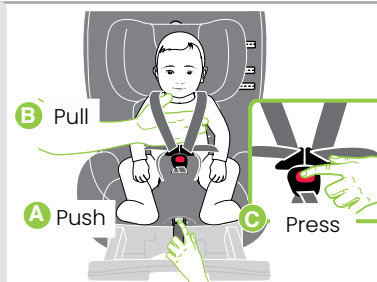

- A.** Loosen shoulder harness straps by pushing the harness adjuster (located under trim).
- B.** Pull both shoulder harness straps evenly.
- C.** Disengage the buckle by pressing the red button.

3.

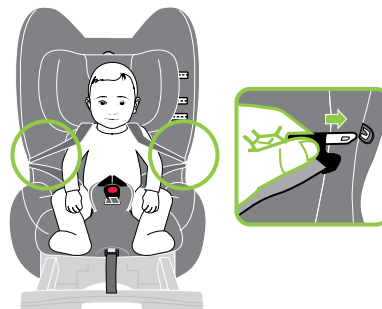

Place harness buckles in buckle tongue holder. Lift child from the child seat.

Set Up – Remove Child Seat From Vehicle For Rearward Facing Seatbelt

1.

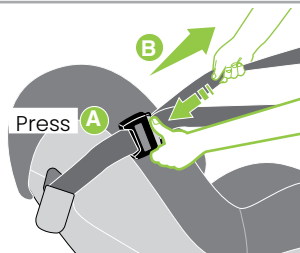

- A.** Press top tether adjuster button and
- B.** Lengthen top tether strap fully .

2.

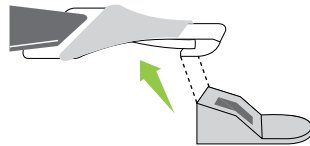

Disconnect top tether attachment clip from vehicle anchorage fitting.

3.

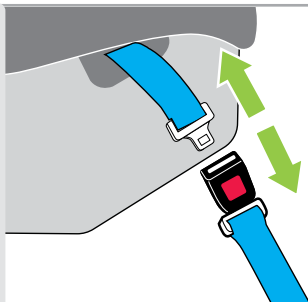

Disengage the vehicle seatbelt buckle.

4.

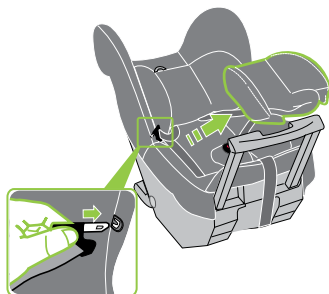

Remove infant insert (if fitted).

IMPORTANT - Ensure buckle tongues are placed into buckle tongue holders.

5.

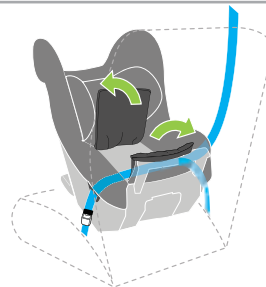

Lift out middle cover.

6.

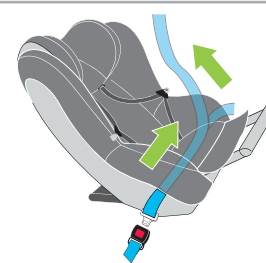

Remove vehicle seatbelt from blue REARWARD FACING BELT PATH.

7.

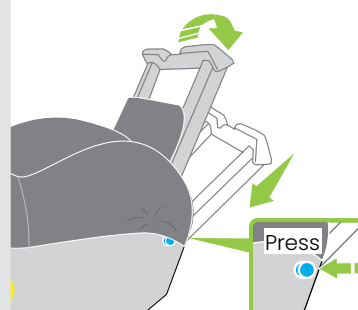

Press the blue release rebound bar button to unlock the rebound bar. Store the rebound bar away.

8.

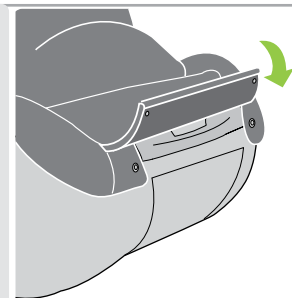

Re-attach the flap at the front of the child seat.

Set Up – Remove Child Seat From Vehicle For Rearward Facing Seatbelt

Set Up - Remove Child Seat From Vehicle For Rearward Facing ISOFLEX®

1.

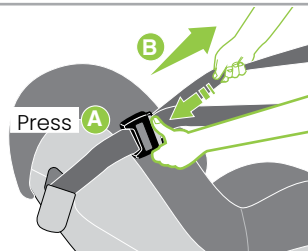

- A.** Press top tether adjuster button and
- B.** Lengthen top tether strap fully .

2.

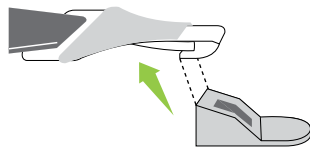

Disconnect top tether attachment clip from vehicle anchorage fitting.

3.

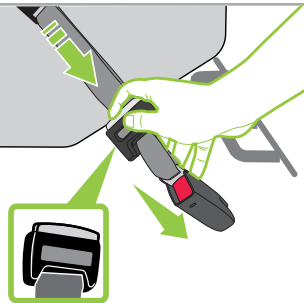

Press the ISOFLEX® adjuster button to release tension on the straps, lengthen fully. Repeat on both connectors.

4.

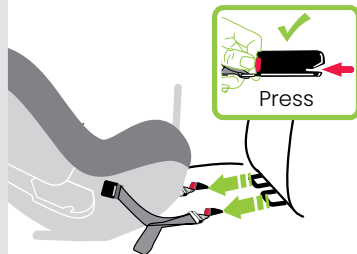

Press the red connector button and remove the ISOFLEX® connectors from the vehicle.

5.

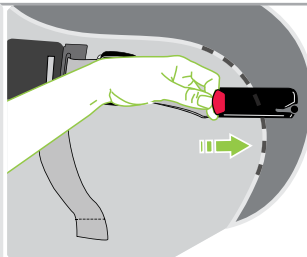

Adjust each ISOFLEX® strap to the shortest length and engage each ISOFLEX® connector onto its storage pin.

6.



Pull trim over ISOFLEX® connectors and hook into place. Store excess straps under the trim.

7.

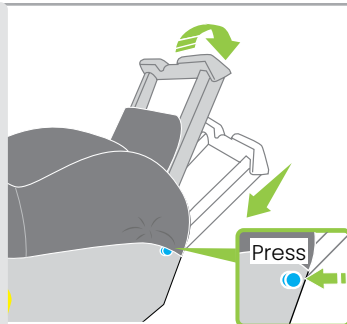

Press the blue release rebound bar button to unlock the rebound bar. Store the rebound bar away.

8.

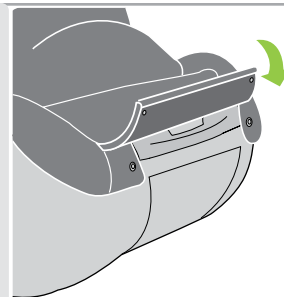

Re-attach the flap at the front of the child seat.

Set Up - Remove Child Seat From Vehicle For Rearward Facing ISOFLEX®

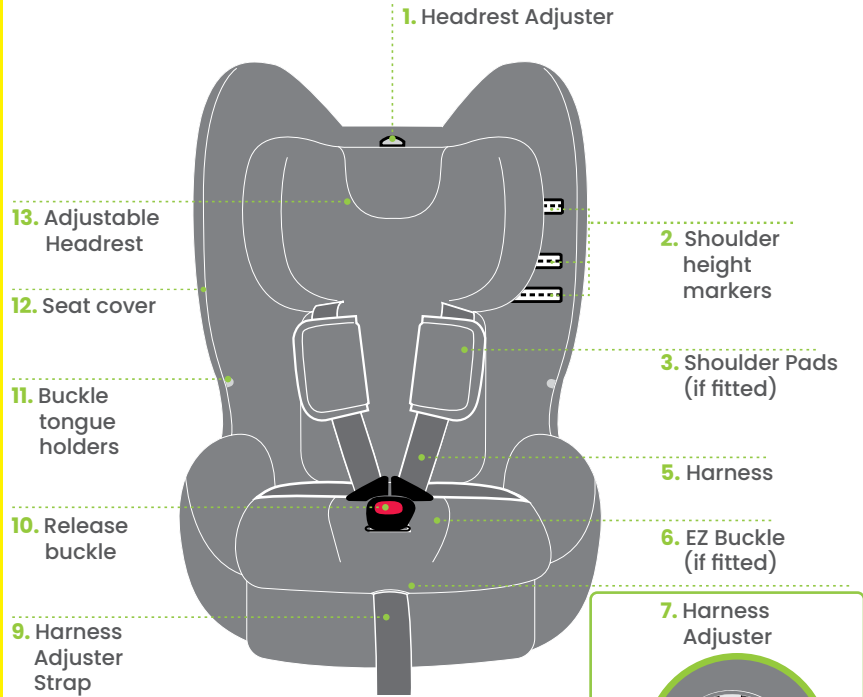

Harness adjuster located under cover

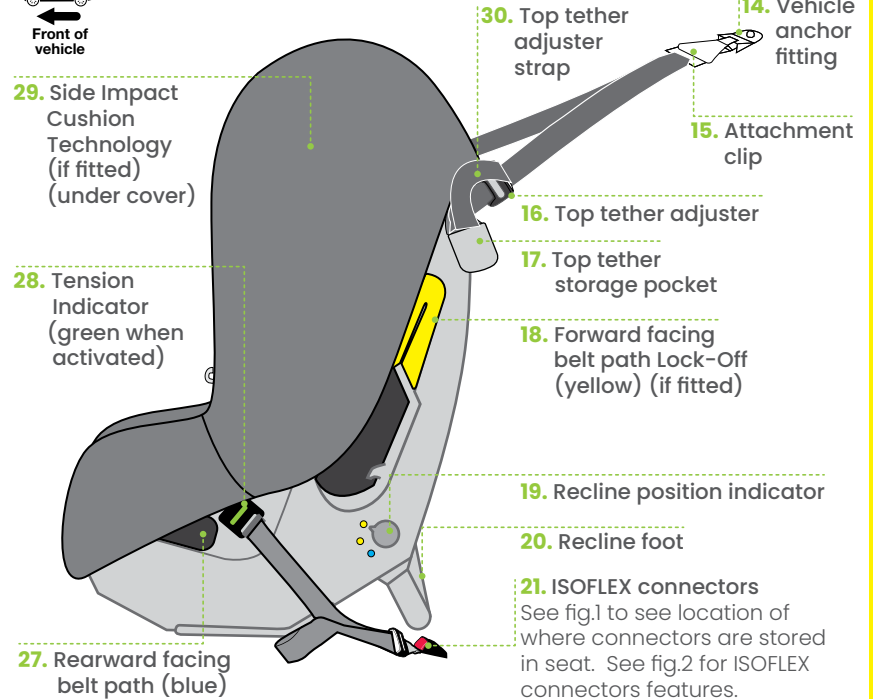
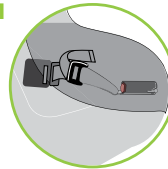

Fig.1



ISOFLEX® Connectors are stored on each side under the seat cover.

Fig.2



ISOFLEX Adjuster strap

ISOFLEX Adjuster

ISOFLEX Release button

ISOFLEX indicator

ISOFLEX Connector

Setup – General Information For Forward Facing

Is there enough room?

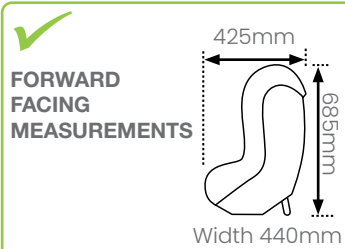

To ensure that the space is sufficient, the purchaser should check the measurements between the vehicle's rear and front seats in which the child restraint is intended to be used for forward facing mode.

1.

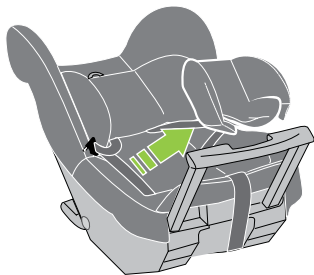

Transition From Rearward Facing To Forward Facing Mode:

Remove infant insert. Shoulder pads and crotch pad may continue to be used if required.

2.

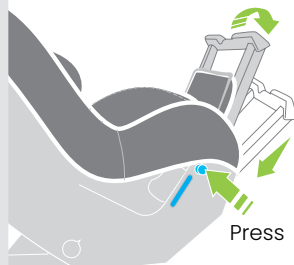

Press the blue release rebound bar button to unlock the rebound bar and slide back into the recess.

3.

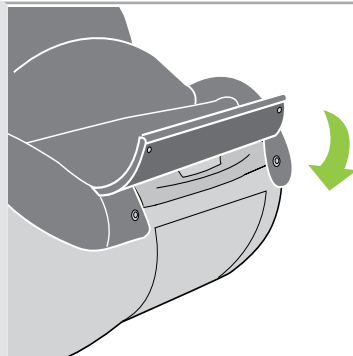

Reattach the flaps and press down the studs.

4.

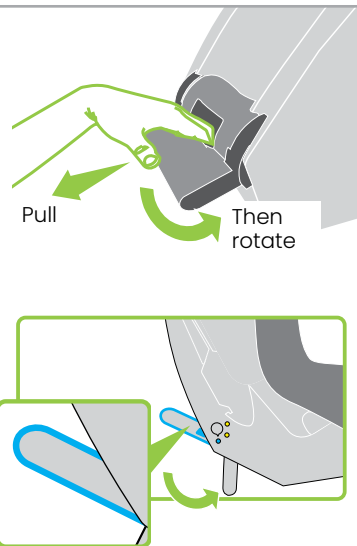

Set recline foot to forward facing mode by pulling the recline foot handle and rotating to the desired position and allow the foot to lock into place.

⚠ WARNINGS

DO NOT USE RESTRAINT IN FORWARD FACING MODE WITH THE REBOUND BAR PULLED OUT.

Do not use the restraint without the top tether strap correctly attached. If an airbag is fitted in the desired seating position where the child restraint is fitted, follow the vehicle manufacturer's warnings and instructions.

Setup – Forward Facing Recline Positions

Setup - Installing Into Your Vehicle For Forward Facing

1.



Choose vehicle seat position.

2.

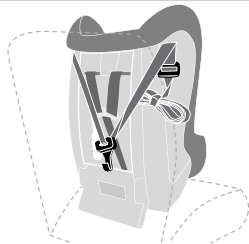

Ensure child seat is against vehicle seatback and top tether is not trapped behind seat. Place top tether and attachment clip over back of vehicle seat towards anchor fitting. See 53 for Forward facing seatbelt installation or page 55 for Forward facing ISOFLEX® installation.

3.

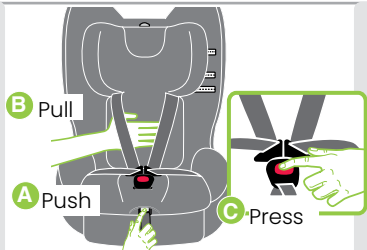

- A.** Push harness adjuster (located under trim.)
- B.** Place your hand under both shoulder harness straps, then pull shoulder harness straps to lengthen.
- C.** Disengage the buckle by pressing the red button.

4.

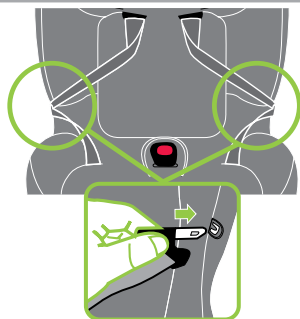

Place buckle tongues into buckle tongue holders.

5.

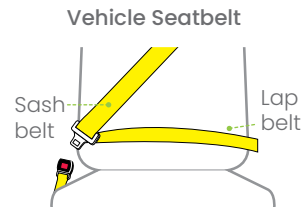

Lengthen vehicle seatbelt.

6.

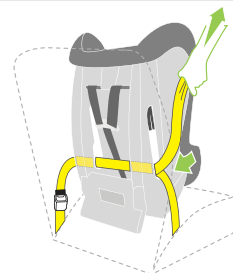

Lengthen vehicle seatbelt and feed vehicle seatbelt through yellow FORWARD FACING BELT PATH guide.



ENSURE THE SEATBELT STRAPS ARE NOT TWISTED.

7.

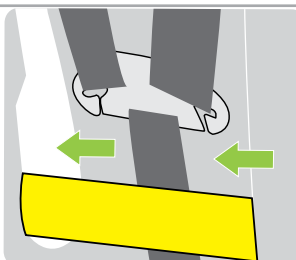

Feed the seatbelt across and out the opposite guide. Ensure seatbelt is behind child seat harness straps and is under the belt path hooks.

8.

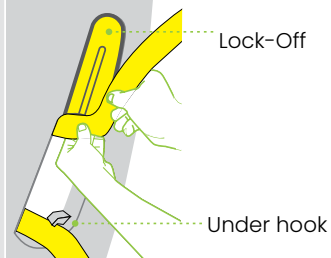

Slide the sash belt through the lock-off (if supplied). Feed any slack back into the retractor. Ensure the lap part of the seatbelt is under the hooks inside the belt path.

Setup - Seatbelt For Forward Facing 53

9. Engage buckle



Engage the vehicle seatbelt buckle and tongue without twists.

10. Push down

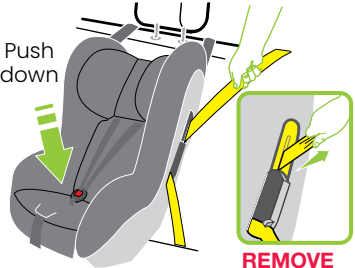

REMOVE SLACK

Apply downward pressure onto the inner seat area and remove all the seat belt slack by pulling the seat belt from the buckle side across the child seat and back into the retractor.

11.

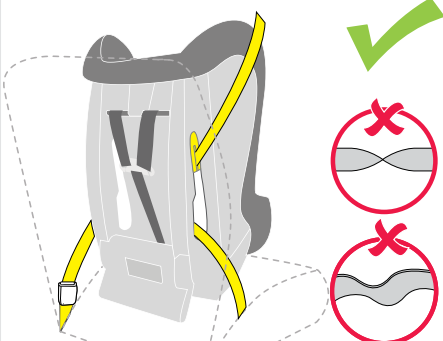

You are now ready to install top tether. Refer to page 57.

ALWAYS REMOVE SLACK FROM SEATBELT.

ENSURE THERE ARE NO TWISTS IN SEATBELT.

Please ensure you have followed the steps on pages 50 - 52

1.

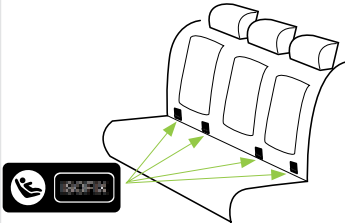

Locate the ISOFIX Low Anchorage in the vehicle rear seat. If you cannot locate the ISOFIX anchorages, check your vehicle owners manual.

2.

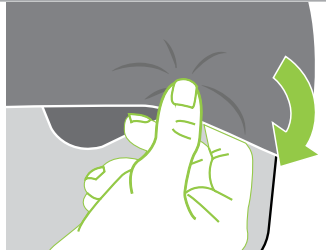

Unhook the clip from the cover to reveal the ISOFLEX® connectors

3.

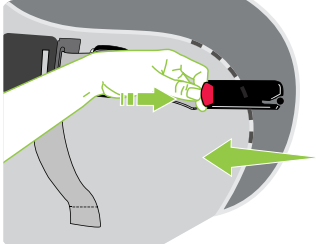

Release both ISOFLEX® connectors on each side of the restraint, by pressing the red button on the connectors.

4.

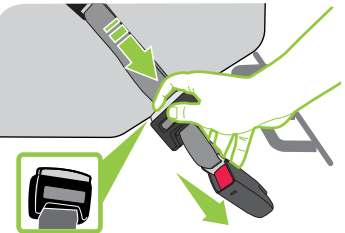

Press

Press and hold the ISOFLEX® adjuster release button and pull the connector strap to fully lengthen. Repeat for the other connector.

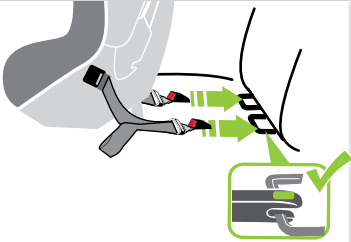
5. 

Connect the ISOFLEX® connectors into each ISOFIX low anchorage. Give a firm tug on the connector to check it is securely fitted. Connectors may also show a green indicator on top.

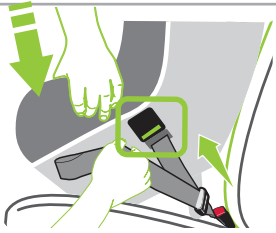
6. 

With the child seat in position, apply firm pressure whilst pulling on adjuster strap to remove all slack and tighten the ISOFLEX® strap. Repeat on the other side of the restraint. The two tension indicators will show green indicating minimum tension has been applied.

7. 

You have now successfully completed the ISOFLEX® installation and are now ready to install the top tether. Please go to page 57. You do not need to seatbelt install with ISOFLEX®.

ENSURE THERE ARE NO TWISTS IN ISOFLEX® CONNECTOR STRAPS.
ALWAYS REMOVE SLACK FROM ISOFLEX® STRAPS.
A LOOSE INSTALLATION IS DANGEROUS

IMPORTANT:
 Do not attach the lower attachment connectors of two separate child restraints to the same ISOFIX low anchorages in your car.
 Always attach the top tether strap to the child restraint upper anchorage in your car.

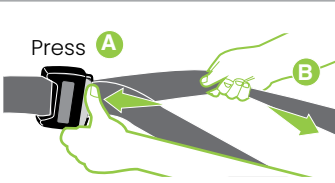
1. 

A. Press top tether adjuster button and
B. Lengthen top tether strap fully.

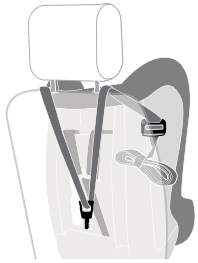
2. 

Place the top tether over the vehicle backseat, and if needed, remove the vehicle headrest. If you cannot remove the headrest, then ensure that the top tether straps are placed on the outer-sides of the headrest.

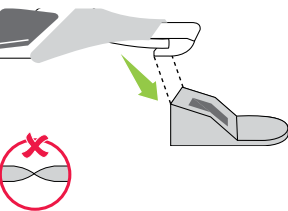
3. 

Connect top tether attachment clip to vehicle anchor fitting. Check your vehicle manual for the correct anchor fittings in your vehicle.
ENSURE THE TOP TETHER STRAPS ARE NOT TWISTED TIGHTLY.
A HALF TWIST IS ACCEPTABLE

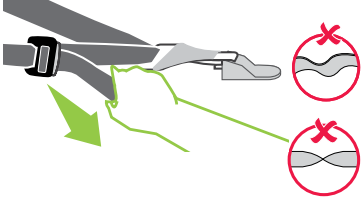
4. 

Ensure slack is removed from the top tether straps by pulling top tether adjuster strap. Do not over tighten as it may cause your child seat to lift.
ALWAYS REMOVE SLACK IN THE TOP TETHER AND STORE STRAP.
ENSURE THE TOP TETHER STRAPS ARE NOT TWISTED.

5. Roll up to store



Roll up any excess strap and store in the pocket provided on the top tether strap.

CAUTION: CHILDREN CAN BE INJURED OR RESTRAINTS AND TOP TETHER STRAP DAMAGED BY UNSECURED CARGO IN A COLLISION. SECURE OR REMOVE HAZARDOUS CARGO BEFORE USING THIS CHILD RESTRAINT.

IMPORTANT:

The top tether strap must be fitted at all times.

Always secure the loose end of the top tether strap to prevent it hanging out of the car or being accessible by the child.

ALWAYS ATTACH TOP TETHER HOOK AND REMOVE SLACK IN THE TOP TETHER STRAP.

Take care to avoid contact with sharp objects which may damage the Top Tether webbing (e.g. Vehicle Headrest poles and pole guides). Remove vehicle headrest if necessary (Refer Vehicle Instruction Manual)

Do not attach the top tether of two separate child restraints to the same vehicle anchorage.

1.

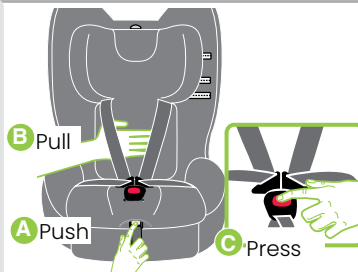

- A. Push harness adjuster (located under trim.)
- B. Place your hand under both shoulder harness straps, then pull shoulder harness straps to lengthen.
- C. Disengage the buckle by pressing the red button.

2.

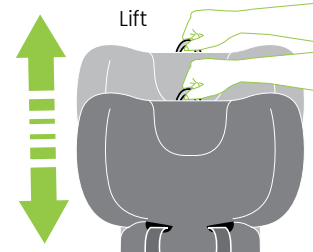

Lift lever to adjust headrest/harness slots. You can remove the vehicle headrest if it interferes with the seat's headrest.

3.

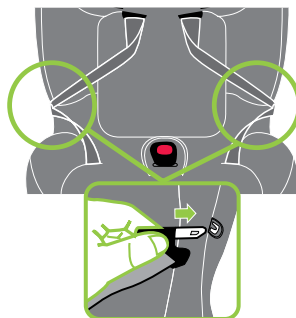

Place buckle tongues into buckle tongue holders.

4.

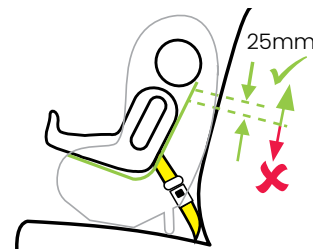

Place child into child seat. Ensure your child sits fully back without slouching.

Set Up – Headrest And Shoulder Harness For Forward Facing

5.



The shoulder straps must be in the slots which are nearest to the child's shoulders, but not more than 25mm below the child's shoulders.

Always adjust the height of the shoulder straps as the child grows.

6.

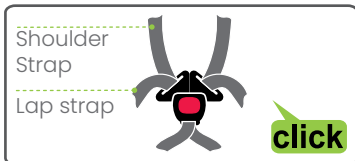
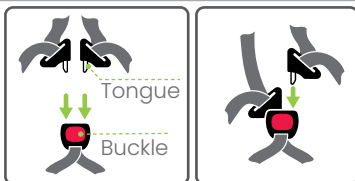

Engage Buckle.

ENSURE BUCKLE IS ALWAYS CONNECTED DURING USE.

ENSURE ALL HARNESS STRAPS ARE NOT TWISTED.

7.

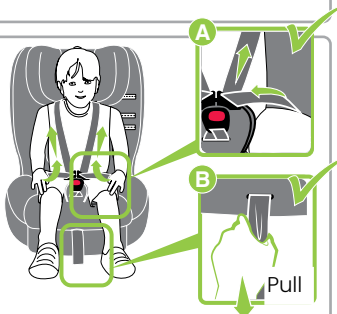

A. Remove all slack from the lap strap area (including behind child's bottom), by pulling up on the shoulder straps.

B. Pull harness adjuster strap to tighten. Ensure a firm but comfortable fit.

REMOVE ALL HARNESS SLACK



WARNING:
DO NOT LEAVE CHILDREN UNATTENDED IN THE CAR.

Setup – Remove Child From Child Seat For Forward Facing

1.

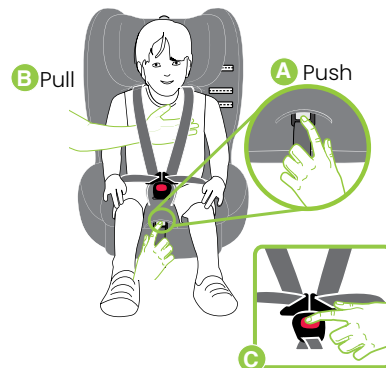

A. Loosen shoulder harness straps by pushing the harness adjuster.

B. Pull both shoulder harness straps evenly.

C. Disengage buckle by pressing red button.

2.

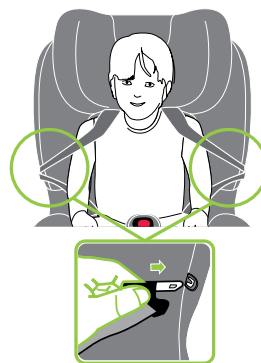

Place harness buckles in buckle tongue holder.

Remove child from child seat.

Setup - Remove Child Seat From Vehicle For Forward Facing Seatbelt

1.  Press **A**. Lengthen top tether strap fully.

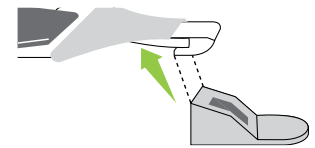
2.  Disconnect top tether attachment clip from vehicle anchorage fitting.

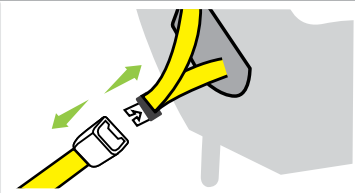
3.  Disengage the vehicle seatbelt buckle.

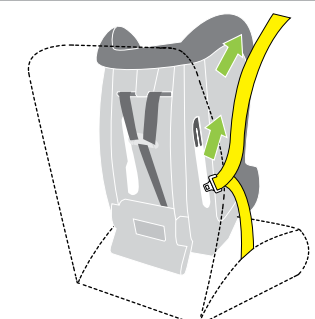
4.  Remove vehicle seatbelt from yellow Forward Facing Belt Path.

Setup - Remove Child Seat From Vehicle For Forward Facing ISOFLEX®

1.  Press **A**. Lengthen top tether strap fully.

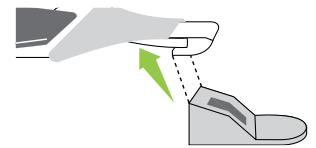
2.  Disconnect top tether attachment clip from vehicle anchorage fitting.

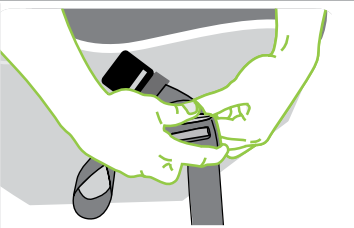
3.  Press the ISOFLEX® adjuster button to release tension on the straps, lengthen fully. Repeat on both connectors.

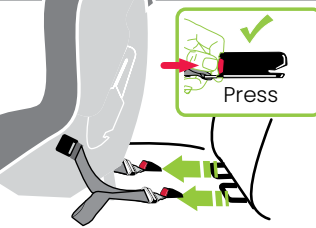
4.  Press the red connector button and remove the ISOFLEX® connectors from the vehicle.

Setup - Remove Child Seat From Vehicle For Forward Facing ISOFLEX®

5.

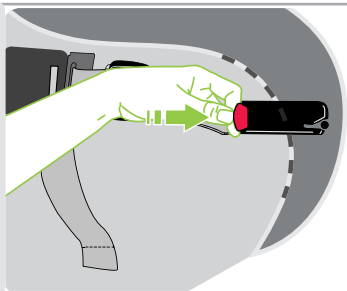

Adjust the ISOFLEX® strap to the shortest length and engage each ISOFLEX® connector onto its storage pin.

6.



Pull cover over ISOFLEX® connectors and hook into place.

This Restraint Is Suitable For Use On An Aircraft When Installed As Directed.

How To Install Using Aircraft Lap Belt

The child restraint must be used in accordance with the aircraft procedures, and any directions from the aircraft operator, pilot or crew.

Some child restraints may not fit in smaller aircraft and can not be used with aircraft seatbelts that contain airbags unless they can be disabled.

Inform the aircraft operator that a child restraint is intended to be used on the aircraft when booking the flight as the child restraint may not be suitable for use in that operator's aircraft.

Follow the instructions of the flight crew or pilot.

For use of the child restraint in cars in countries other than Australia and New Zealand as follows:

- (A) The child restraint may not be acceptable for use in cars.
- (B) The user may need to consult the country's local authorities, car hire companies, car insurance companies, etc. for advice.

1.

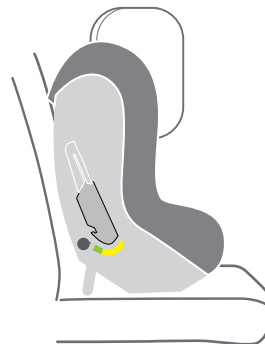

To Fit The Child Restraint To The Aircraft Seat In Forward Facing:

Set the recline foot position to fully upright. Position the restraint in forward-facing mode and align centrally with the chosen seating position. We recommend to fit the restraint nearest the window or in a middle seat if in centre seating area, so it will not interfere with an adult exiting the row of seats. If possible, lift the armrests out of the way to improve access to installing the aircraft lap belt. However airline staff will direct you to the desired seat position.

2.

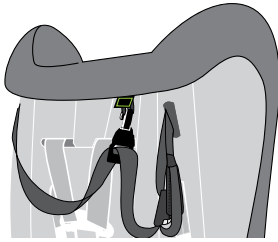

The top tether is not required to be used to fit the child restraint in an aircraft. Shorten the top tether strap and store in its storage pocket. Attach the tether clip to the elastic loop provided on the restraint as shown.

**IMPORTANT:**

When the tether hook is stored on the loop always remember to attach the upper tether strap when reinstalling in the car.

4.

Ensure seatbelt is below the hooks on both sides

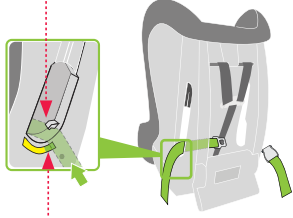
**AIRCRAFT SEATBELT PATH;**
marked in green.

Fully lengthen seatbelt. Thread the seatbelt into AIRCRAFT SEATBELT PATH seatbelt path marker (lower green marker) as shown, ensuring that the seatbelt is behind the harness straps and below the hook as shown, on each side.

5.

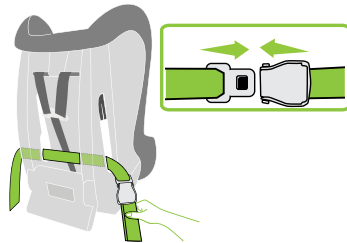

Engage seatbelt buckle and tongue. Push down on the restraint and remove all slack from the seatbelt.

Place child in the seat, fit the harness, engage buckle and remove any slack in the harness.



This Child Restraint System meets the standards for use in aircraft as recommended by the Civil Aviation Safety Authority of Australia and the Civil Aviation Authority of New Zealand.

Only to be used on aircraft with the permission of the aircraft operator, pilot and crew.

SUITABLE FOR FORWARD USE

The top tether strap is not required to be used onboard aircraft and should be stowed securely.

Aircraft label is located on the back of the restraint and demonstrates suitability for use on an aircraft.

Regular Care Of This Restraint:

Please check the following items regularly to ensure the safety of your child.

- Check the condition of the harness straps, i.e. No damage or fraying.
- Check the condition of the seat structure, i.e. No cracks or other forms of damage.
- Check the harness adjuster is operating correctly.
- Ensure the buckle is free of fluff, liquid or other matter that may enter the buckle opening. Clean the buckle if it is difficult to engage. See next page. Immediate repair is required if any of the above issues are observed. Contact Britax® Customer Service 1300 303 330.
- Regularly check the restraint components, straps and other fitments for correct function and condition. If faulty, cease using and seek repair by Britax®.
- Protect all webbing from abrasion and cutting by sharp corners and edges.
- Regularly vacuum under the seat cover to remove accumulated food etc. Pay particular attention to Lower Adjuster area as food ingress can allow webbing to slip.

Cleaning Child Seat

HARDWARE: Use only mild soap to clean all metal and plastic parts of your child's restraint, using a damp sponge or cloth. Do not use chemicals or cleaning agents. Do not try to place any hardware into a washing machine.

STRAPS/HARNESS: We recommend spot cleaning straps and harness with a damp sponge or cloth using only cold or warm water. Never place any straps or harness into a washing machine or tumble dryer.

Washing Care For Cover

- Gentle Cold Machine Wash
- Do Not Bleach, Soak Or Wring
- Do Not Tumble Dry
- Do Not Dryclean
- Dry Flat In Shade
- Do Not Iron

Buckle Operation

To ensure the buckle remains operational, the inside of the buckle must be kept free of liquids, sand, dirt, fluff, food or similar substances. If the buckle is not operating or you do not hear a strong audible click when the second tongue is inserted then the buckle needs to be washed or replaced. The buckle is fully engaged when both tongues are inserted and a 'click' is heard. Contact Customer Service for assistance.

Clean Harness Buckle:

If sticky liquids such as baby formula, fruit juice, etc. get inside your harness buckle, it may become sluggish. An indication of a sluggish harness buckle is that you cannot hear a click when engaging the second harness tongue. To restore the harness buckle to good working order it needs to be cleaned as follows:

1.

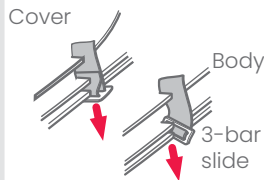

To remove the harness buckle from the restraint: From the underside of the child seat pull out each metal 3-bar slides. Turn each metal 3-bar slide on its side and push back through the slots, aligning the slide to pass through all slots in hardware.

2.

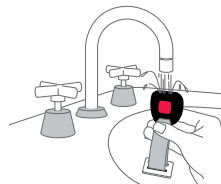

Place the harness buckle under warm (max. 40 degrees celsius) running water as shown below. Let the water run through the mouth of the buckle for five minutes. Check the harness buckle is clean by engaging the harness tongues and buckle several times until you hear a click.

3.

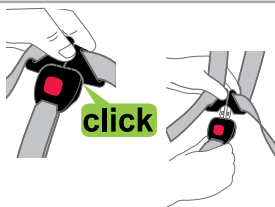

If you still cannot hear a strong audible click then repeat the cleaning process several times. Refit the harness buckle to the restraint ensuring the red button facing outwards and the 3-bar slide is fed through the same slots. If the harness buckle cannot be returned to its original working condition then contact Britax® Customer Service for assistance.

1.



NOTE: There is no need to disconnect the shoulder harness assembly straps from restraint. Remove the restraint from vehicle. Disengage the harness tongues from the harness buckle. Remove any accessories, infant insert, crotch pad and shoulder pads (if supplied).

2.

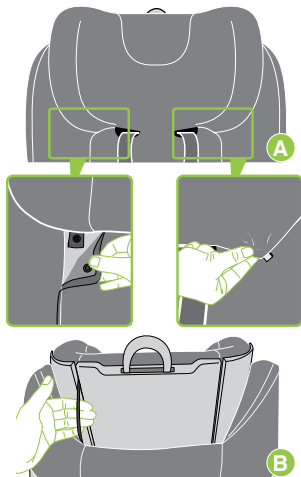

To Remove Headrest Cover:

- A. Lift headrest to the highest position and unclip press studs on both sides, then unhook clips on both sides attached under headrest wings.
- B. Behind the headrest reveal the hidden elastic, lift out and remove elastic over and away from headrest. Peel headrest cover away.

3.

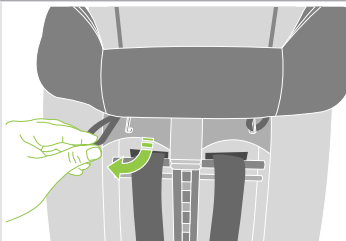

To Remove Cover:

At the back of the child seat locate and unhook the elastic loops.

4.

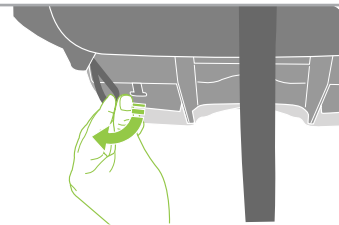

Recline child seat to reveal elastic loops at the lower front of the child seat and detach from hooks.

5.

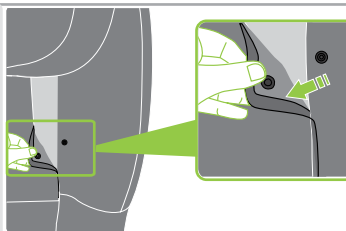

Unclip press studs from middle cover of child seat and crotch buckle.

6.

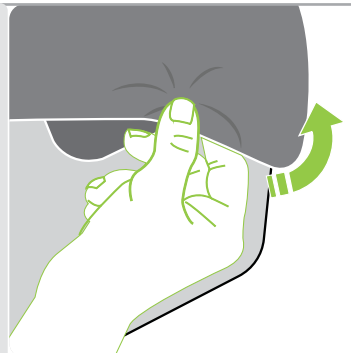

Unhook the clip from the cover to reveal the ISOFLEX® connectors.

7.

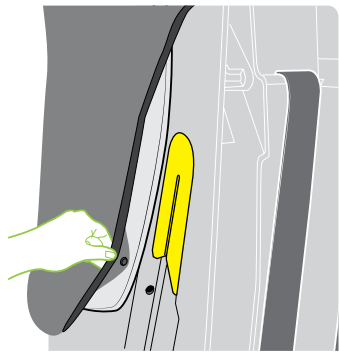

If fitted with SICT™ remove press stud from the both sides of the shell behind the SICT.

**IMPORTANT:**

Do not remove the impact foam attached to the side wings. Ensure the shoulder harness is routed over the bar if harness straps are removed.

1.

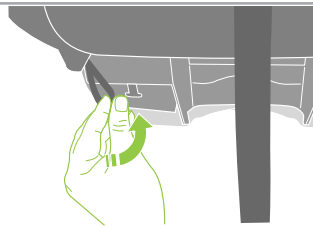

Stretch the cover over the headrest and harness adjuster button. Ensure none of the harness straps are twisted.

Recline child seat to reveal hook at the lower front of the child seat and attach elastic loops.

2.

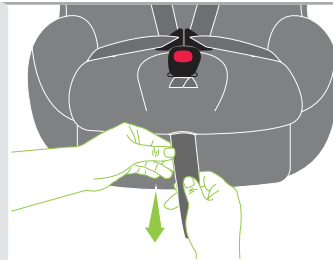

Pull the adjuster strap through the cover.

3.

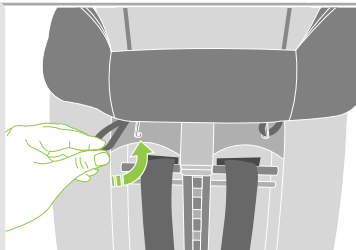

At the back of the child seat attach the hook the elastic loops to hooks provided.

4.

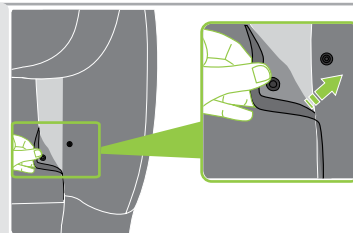

Attach press studs to middle cover found inside child seat and crotch buckle.

5.



Unhook the clip from the cover to reveal the ISOFLEX® connectors.

2.



To Replace Headrest Cover:

A. Lift headrest to the highest position. Stretch headrest cover over headrest. Replace elastic behind headrest into the recess.

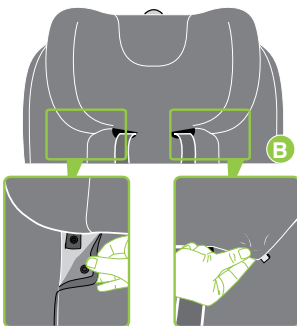

B. Attach press studs and hook the clips under headrest wings.

7.

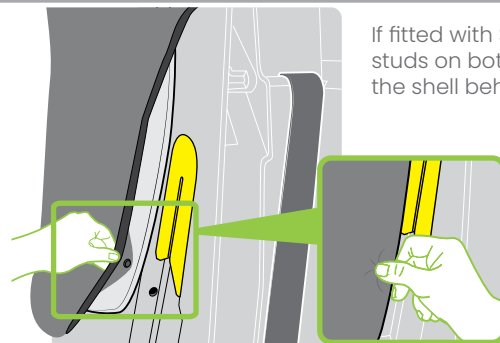

If fitted with SICT™ replace the press studs on both sides of the restraint in the shell behind the SICT.

ONLY USE BRITAX® SEAT COVERS AND ACCESSORIES THAT ARE DESIGNED AND TESTED FOR USE WITH THIS PRODUCT.



VERY IMPORTANT:

Only replace the cover with Britax® supplied replacement cover with identical shoulder height markers or a replacement cover meeting AS/NZS 8005.

The following instructions apply to accessories that may be supplied with this restraint at point of purchase. The accessories are for comfort use only. Use of aftermarket accessories, which are accessories not provided with this child restraint, can reduce the safety provided by the child restraint and may cause injury or death. Always follow the instructions covering the use of accessories provided with this child seat and the instructions provided with the accessory. If an aftermarket accessory is used that is not recommended by Britax®, ensure that the accessory is compliant with AS/NZS 8005 and is stated as suitable for use with this specific child restraint.

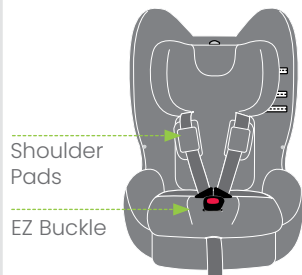

Shoulder Pads (If Supplied)

Shoulder Pads give extra comfort for your child when using the harness. They're easy to remove and it makes washing them a breeze - unclip the studs to clean them and fit them back onto the shoulder harness straps once done.

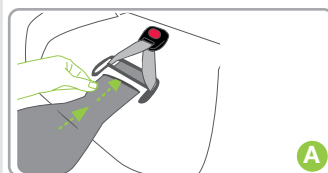

Ez Buckle (If Supplied)

The EZ Buckle makes it easier to place your child in and out of the child seat. It prevents your child from sitting on the buckle when seated in both rearward and forward facing modes.

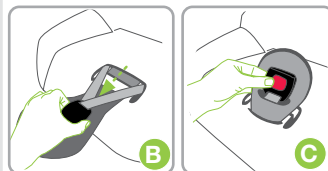

To remove

Feed the crotch buckle through the EZ buckle slot. Remove EZ Buckle.

To replace

Feed EZ Buckle through base cover front slot. Feed crotch buckle through EZ buckle slot. EZ Buckle is behind the buckle. See illustration C.

Infant Inserts (If Supplied)

For use until infant reaches the lower height marker (approx 18mth old)

There are 3 types of infant inserts:

Designed to provide additional support for smaller babies. Discontinue use at the lower height marker or when the insert is a tight fit or creates discomfort for larger babies.

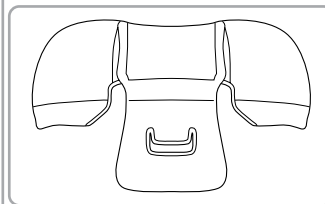

The Flexi Infant Comfort Insert

Designed to support smaller babies. The wings/side panels can be easily detached by unclipping the press studs, allowing you the flexibility to keep or remove panels as your baby grows. Discontinue use at the lower height marker or when the insert is a tight fit or creates discomfort for larger babies.

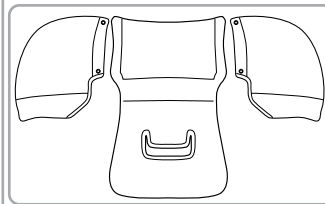

Newborn Insert

Designed to offer maximum support for smaller babies. The Newborn Insert can be used 'stacked' on top of either the Infant Insert or the Flexi Infant Comfort Insert or it can be used on its own. Discontinue use at the lower height marker or when your baby no longer requires the additional support.

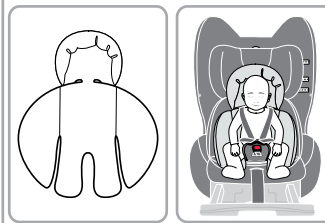

To replace infant insert

- Disconnect the buckle and place the insert under the shoulder and lap straps.
- Feed the crotch strap through the insert and re-connect buckle.
- If using the Flexi Infant Comfort Insert, re-attached side wings if required.

Long Vehicle
Seat Protector
(If supplied)

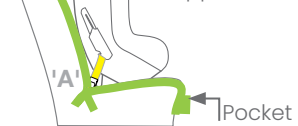

Vehicle Seat Protector (If Supplied)

The Vehicle Seat Protector has been specifically designed to protect your vehicle seat when using your child seat.

Place pocket on edge of seat, smooth back toward seat join ('A') and fit in any excess Vehicle Seat Protector into the join of the vehicle seat ('A').



CAUTION:

The Vehicle Seat Protector pocket is designed for small, light items. To avoid damage do not overload the pocket.

Short Vehicle
Seat Protector
(If supplied)

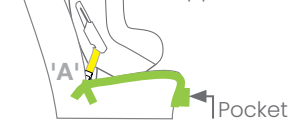

Note: Some Vehicle Seat Protector may not have pockets.

Consult the vehicle owner's handbook for location of anchorage fittings or anchorage points and the possible use of spacers. Some vehicles may have an anchor fitting fitted by the vehicle manufacturer. If anchorage points cannot be found refer to car manufacturer or local child restraint fitting station or traffic authority for optimum position of upper anchorage point and the use of spacers.

TOP TETHER STRAP



IMPORTANT:

THE ATTACHMENT CLIP COVER MUST ALWAYS BE USED AS IT PREVENTS THE RISK OF INCORRECT FITMENT OF THE ATTACHMENT CLIP TO THE UPPER ANCHORAGE POINT. BEFORE EACH USE OF THE RESTRAINT ALWAYS ENSURE THAT THE ATTACHMENT CLIP IS CORRECTLY ENGAGED TO THE UPPER ANCHORAGE POINT AND NOT HOOKED TO OR FITTED TO, ANY OTHER OBJECT. THIS IS ESPECIALLY IMPORTANT IN VEHICLES SUCH AS STATION WAGONS, VANS, HATCH BACKS OR VEHICLES WITHOUT A FIXED PARCEL SHELF, SINCE THE ANCHOR POINT IS USUALLY NOT VISIBLE.

IMPORTANT INSTALLATION NOTE:

In some vehicles the upper anchorage point in the rear vertical panel can only be installed in one way. Please refer to vehicle owner's handbook or a child restraint fitting station for correct method.

Extension Straps
 Length 300mm (Use Britax Safe-n-Sound® part 0035 or 0291).
 Length 600mm (Use Britax Safe-n-Sound® part 0036 or 0290).
 Available from all major child restraint retailers.

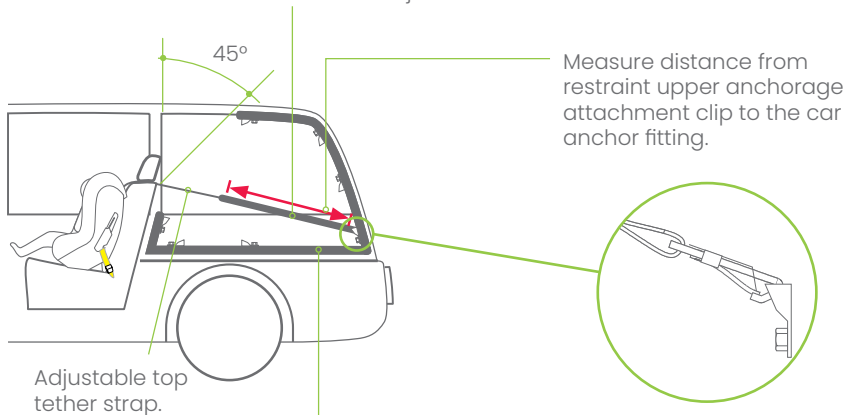

The shaded areas of this diagram illustrate the possible locations of the upper anchorage point (car anchor fitting). Within each shaded area is an upper anchorage point showing the correct way to install the fitting. Ensure the upper anchorage point is aligned as illustrated unless stated otherwise in the vehicle owner's handbook.

UPPER ANCHORAGE FITTING

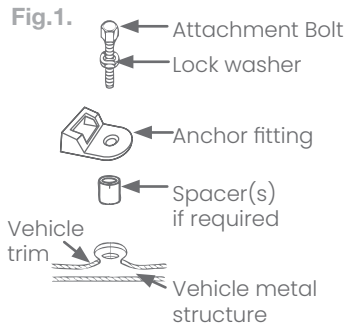

IF THE CAR IS FITTED WITH A CHILD RESTRAINT UPPER ANCHORAGE POINT
 Locate the upper anchorage point behind the rear seating position (Consult the car owners handbook for the location of the upper anchorage point). The upper anchorage point should be directly behind and central to the restraint. Remove thread plug from the parcel shelf/floor/roof, etc. and install attachment bolt and fitting as shown in Fig 1.



CAUTION: DO NOT OVERTIGHTEN ATTACHMENT BOLT. OVERTIGHTENING MAY FRACTURE OR BREAK BOLT. MAXIMUM TORQUE IS 20 Nm (14.75 ft.lb.)

Note: Minimum of five full turns of attachment bolt is required before tightening force is applied.

UPPER ANCHORAGE FITTINGS FOR SEDANS ONLY

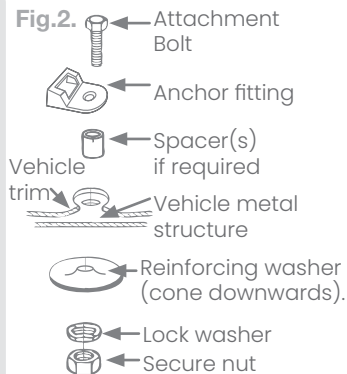

IF THE CAR IS NOT FITTED WITH A CHILD RESTRAINT UPPER ANCHORAGE POINTS For Sedans only - Drill 9mm diameter hole in the parcel shelf on the centre line of the seating position as shown in Fig 3. Before drilling the hole, check the underside for accessibility. Install the attachment bolt as shown in Fig 2. It is recommended that this installation be carried out by a child restraint fitting station or licenced motor mechanic.

For vehicles other than Sedans - In Australia, consult your nearest child restraint fitting station or traffic authority for vehicle inspection to find the best, correct position for the placement of the upper anchorage point, and for the correct attachment bolt length and use of spacers. In New Zealand, consult the agent for the vehicle. Note to Queensland purchasers: The installation of anchorage points must be approved by authorised officers appointed by Queensland Transport. Authorised officers can be sourced from all Queensland Transport Customer Service and Queensland Ambulance Service Centres.



NOTE: Marking on the top of a Grade 5 Bolt. Do not use any bolt without these marks.

ONLY USE A 5/16 UNC GRADE 5 BOLT. IF THE BOLT IS NOT THE CORRECT LENGTH THE CAR MANUFACTURER'S HAND BOOK CAN PROVIDE ADVICE ON THE CORRECT LENGTH BOLT.

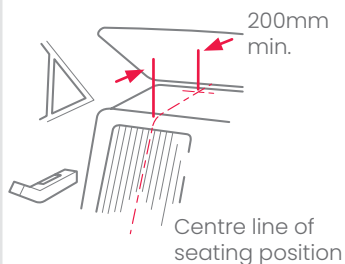

Fig.3.

⚠ WARNING

CHILD RESTRAINTS MUST NOT BE ATTACHED TO UNSOUND METAL OR TO WOOD, OR SYNTHETIC STRUCTURES. WHEN DRILLING 9 MM HOLE DO NOT DRILL THROUGH FUEL LINES, FUEL TANKS, ELECTRICAL WIRING, OR RADIO SPEAKERS. WEBBING STRAPS MUST BE PROTECTED FROM SHARP CORNERS AND EDGES. THE ANCHOR FITTING MUST BE USED ONLY AS DESCRIBED ABOVE. IT MUST NOT BE HOOKED ONTO ANY OTHER OBJECT.

Car Installation Accessories

(From retailers of Britax Safe-n-Sound® products)

Extra Anchor Kits: Available for using the restraint in additional cars.

Re-order no: 0038 or 0289

Extension Straps: May be required for cars without a fixed parcel shelf.

Re-order no: 0035 or 0291 (Length 300mm) or
0036 or 0290 (Length 600mm)

Crash Exchange

We would never want you to experience an accident, but unfortunately accidents do happen.

If you experience an accident you may be eligible for a free replacement.

The Britax Safe-n-Sound® Crash Exchange Program is a voluntary program designed to ensure our children are safe and that any seat that may have experienced a severe crash is taken out of the market.

There is no method of determining if the restraint has been damaged in a severe crash, so the restraint should be destroyed as the crash may reduce the child restraint's ability to perform.

Since its inception in 2006, the Crash Exchange program has helped hundreds of families ensure their children have new restraints and that the restraints are not sold second hand placing others at risk.

If your restraint has been involved in a severe crash, you should destroy the restraint even if no damage is obvious. Restraints are eligible for exchange if they have been involved in a severe crash in Australia or New Zealand and meet all stated criteria. (A severe crash is considered as being one where the main body structure of the vehicle is distorted).

The Britax Safe-n-Sound® child safety restraints are available for exchange under this program.

Contact your insurance company for further details. Your insurance company may require you to keep the child restraint for assessment, **but do not use the child restraint after a severe crash.**

Refer to the Britax® crash exchange website for more details.

Our Crash Exchange Terms and Application form are accessible on our website. Please visit britax.com.au/britax.co.nz for further information.

**Notice To Insurance Company Child Restraint Involved In An Accident**

All Britax Safe-n-Sound® child restraints are manufactured to Australian/New Zealand Standards AS/NZS1754-2013 which require us to advise users of child restraints to "Destroy the entire restraint if it has been in use in a severe crash, even if no damage is obvious". The joint Australian/New Zealand Standards committee CS/85, advise that this statement applies whether a child was in the child restraint or not. A severe crash, we consider as being one where the main body structure of the vehicle is distorted.

There is no method of determining if the restraint has been damaged and we concur with the Australian/New Zealand Standards in recommending destruction of the child restraint.

This notice is to advise you of the requirements of the Australian/New Zealand Standards and our obligation in complying with the standards.

Please assist the owner of this restraint in their claim.

Australia

Britax Childcare Pty. Ltd.

A.B.N 55 006 773 600

Head office and registered address:

Level 4, 650 Lorimer Street, Port Melbourne, VIC, 3207

P.O. Box 5119 Garden City, VIC, 3207

Customer Service 1300 303 330

Email aunz-support@britax.com

britax.com.au

New Zealand

Britax Childcare (NZ) Ltd.

Customer Service 0508 688 822

Email nzoffice@britax.com

britax.co.nz

International Enquirers

Contact your local Distributor

Britax and Britax Safe n Sound are registered trademarks of Britax Childcare Pty Ltd.

ABN 55 006 773 600



Scan QR code for
features, how to use
and installation.

Series No. BS3400A-i20133
BS3400B-i20133
P/No.2203501/A

WARRANTY

Our goods come with guarantees that cannot be excluded under the Australian Consumer Law. You are entitled to a replacement or refund for a major failure and compensation for any other reasonable foreseeable loss or damage. You are also entitled to have the goods repaired or replaced if the goods fail to be acceptable quality and the failure does not amount to a major failure. For the full terms of the Warranty refer to the Britax® website www.britax.com.au/service-support/warranty, www.britax.co.nz/service-support/warranty In our constant pursuit of excellence, we may alter this product and specification without notice. This product may be covered by Australian and International patents and designs or pending applications. Britax Safe-n-Sound®, Safe-n-Sound®, Babylove® and Hipod® are registered trademarks of Britax® Childcare Pty Ltd. All Britax Safe-n-Sound®, Safe-n-Sound®, Babylove® and Hipod® model names are trademarks of Britax® Childcare Pty Ltd.