



IMPORTANT:

KEEP THIS BOOKLET IN THE PLACE PROVIDED ON THE CHILD RESTRAINT

Harnessed Booster Seat

INSTRUCTION BOOK

Series No.: BL0090F-0201 33

baby 
love®

QUICK SETUP - HARNESSSED CHILD

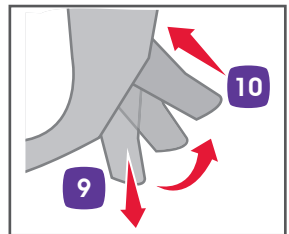
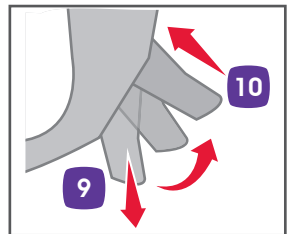
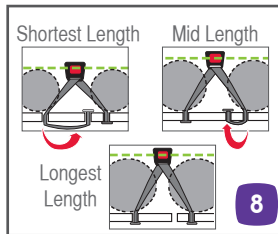
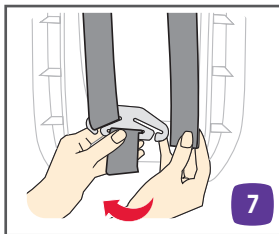
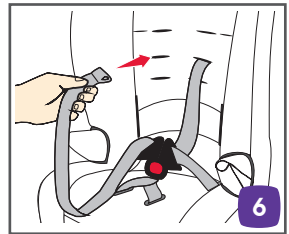
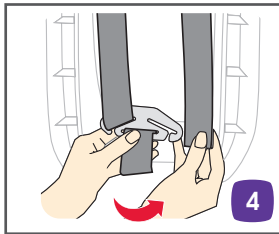
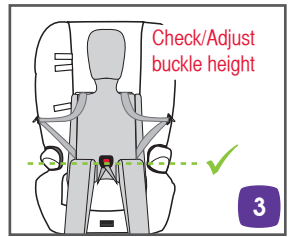
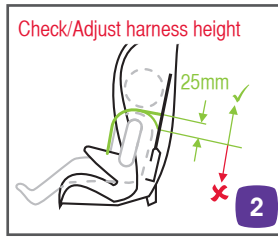
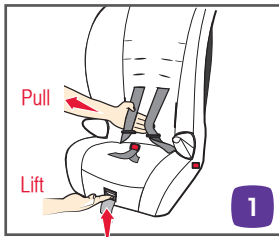

QUICK SETUP - HARNESSSED CHILD

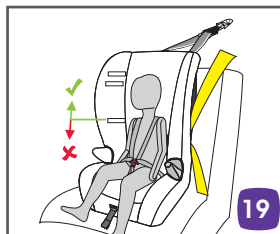
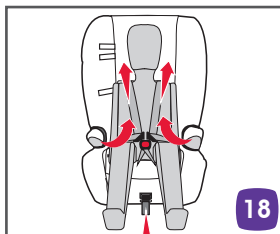
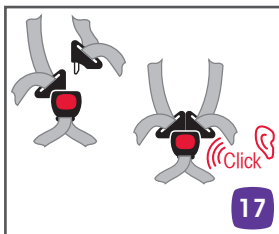
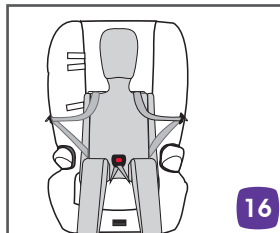
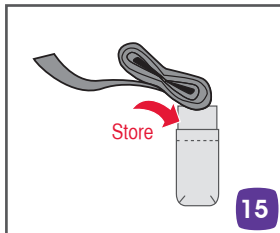
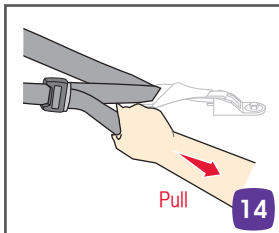
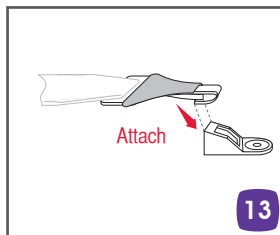
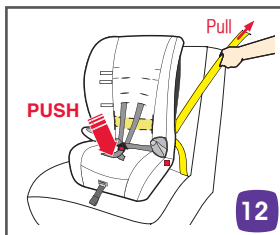
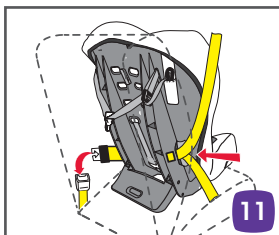

QUICK SETUP - WITH SEATBELT

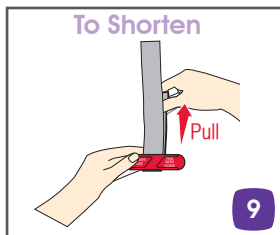
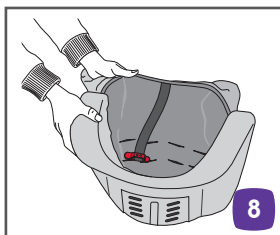
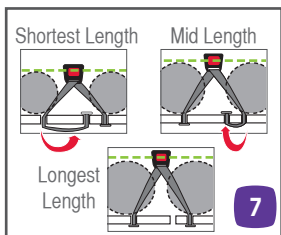
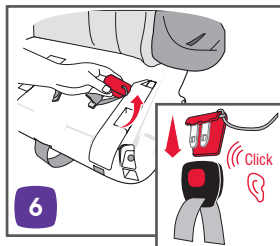
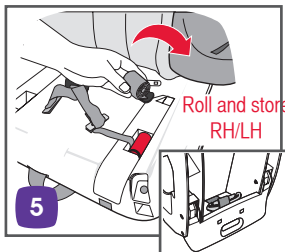
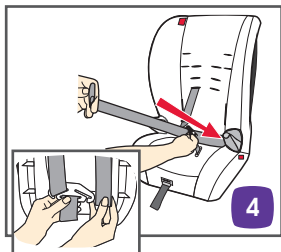
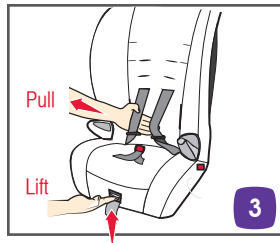
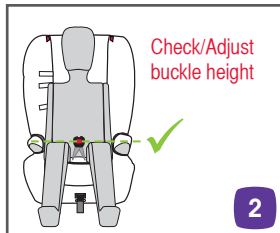
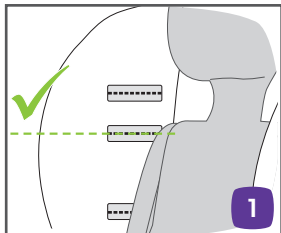

QUICK SETUP - WITH SEATBELT

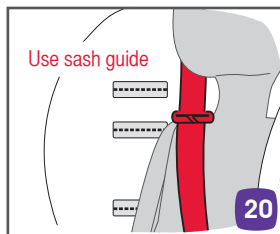
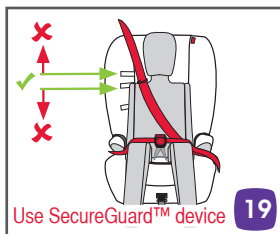
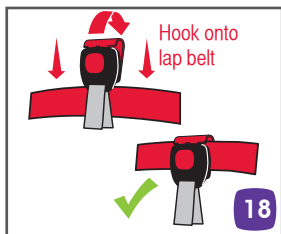
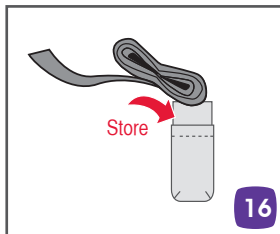
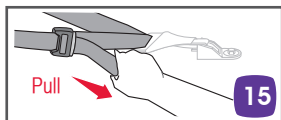
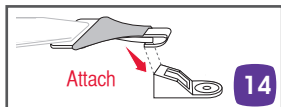
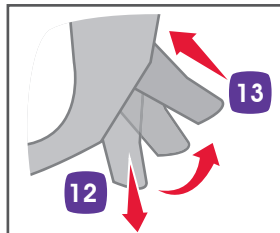
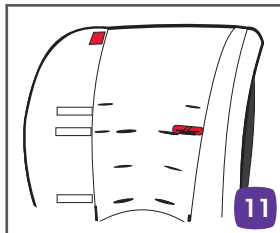
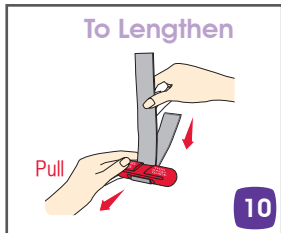

INTRODUCTION

To be used in a forward-facing position with built-in harness by a child whose shoulders are above the lower shoulder height marker (approximately 6 months of age) until their shoulders reach the middle shoulder height marker (approximately 4 years of age).

Then to be used with a lap-sash seatbelt until the child's shoulders reach the upper shoulder height marker (approximately 6 to 8 years of age).

Continue to use this child restraint until the child reaches this limit. Children are safest in a booster seat until their shoulders reach the upper shoulder height marker of the booster seat.

Do not use this child restraint until child's shoulders are above the lower shoulder height marker.

If the knees do not bend in front of the vehicle seat cushion continue to use a booster seat.

Just using a seatbelt is not recommended for children that have outgrown this seat. Use a larger booster seat.

يُستخدم في اتجاه أمامي مع حزام أمان مدمج مع مالم الأمامي إلى أن يلامس كتف الطفل علامة الكتف المنخفضة (تقريباً 6 أشهر) حتى يلامس كتف الطفل علامة الكتف المتوسطة (تقريباً 4 سنوات).

يستخدم مع حزام الكتف والخصر حتى يلامس كتف الطفل علامة الكتف المنخفضة (تقريباً 6 إلى 8 سنوات).

استخدم هذا مقعد الطفل حتى يصل الطفل إلى هذا الحد. الأطفال أكثر أماناً في مقعد تعزيز حتى يلامس كتف الطفل علامة الكتف المتوسطة.

لا تستخدم هذا مقعد الطفل حتى يلامس كتف الطفل علامة الكتف المنخفضة (تقريباً 6 أشهر) حتى يلامس كتف الطفل علامة الكتف المتوسطة (تقريباً 4 سنوات).

استخدم هذا مقعد الطفل حتى يصل الطفل إلى هذا الحد. الأطفال أكثر أماناً في مقعد تعزيز حتى يلامس كتف الطفل علامة الكتف المتوسطة.

لا تستخدم هذا مقعد الطفل حتى يلامس كتف الطفل علامة الكتف المنخفضة (تقريباً 6 أشهر) حتى يلامس كتف الطفل علامة الكتف المتوسطة (تقريباً 4 سنوات).

لا تستخدم حزام الأمان فقط للأطفال الذين تجاوزوا مقعد تعزيز هذا المقعد. استخدم مقعد تعزيز أكبر.

Được sử dụng ở vị trí hướng mặt về phía trước với dây nịt gắn sẵn cho em nào có vai trên vạch ghi ở dưới cùng (khoảng 6 tháng tuổi) cho đến khi vai của em cao tới vạch ghi độ cao của vai ở giữa (khoảng 4 tuổi).

Sau đó được sử dụng với dây nịt an toàn quàng qua vai cho đến khi vai em cao tới vạch ghi độ cao của vai ở trên cùng (khoảng 6-8 tuổi).

Cũng có thể được sử dụng với đai nịt được chấp thuận cho sử dụng với ghế em bé này trong kiểu ghế trẻ em.

Hãy tiếp tục sử dụng ghế em bé (restraint) này cho đến khi em cao tới giới hạn này. Trẻ em được an toàn nhất trong ghế trẻ em cho đến khi vai của em cao tới vạch ở trên cùng của ghế trẻ em.

Không sử dụng ghế em bé này cho đến khi vai của em ở trên vạch ghi độ cao của vai ở dưới cùng.

Nếu đầu gối không co lại đằng trước đệm ghế xe, hãy tiếp tục sử dụng ghế trẻ em (booster).

Chỉ sử dụng dây nịt an toàn không được đề nghị cho trẻ em lớn hơn ghế này. Hãy sử dụng ghế trẻ em (booster) rộng hơn.

INTRODUCTION

Na χρησιμοποιείται σε θέση με κατεύθυνση προς τα εμπρός με ενσωματωμένο ιμάντα από ένα παιδί του οποίου οι ώμοι είναι πάνω από τον χαμηλότερο δείκτη ύψους ώμου (περίπου 6 μηνών) μέχρι οι ώμοι να φτάνουν στο μεσαίο δείκτη ύψους ώμου (περίπου 4 ετών).

Στη συνέχεια, πρέπει να χρησιμοποιείται με ζώνη ασφαλείας τριών σημείων μέχρι οι ώμοι του παιδιού να φτάνουν στον ανώτερο δείκτη ύψους ώμου (περίπου 6 έως 8 ετών).

Μπορεί επίσης να χρησιμοποιηθεί με τον παιδικό ιμάντα που έχει εγκριθεί για χρήση με αυτή την παιδική διάταξη συγκράτησης σε λειτουργία βοηθητικού καθίσματος.

Συνεχίστε να χρησιμοποιείτε αυτή την παιδική διάταξη συγκράτησης έως ότου το παιδί φτάσει σε αυτό το όριο. Τα παιδιά είναι ασφαλέστερα σε ένα βοηθητικό κάθισμα μέχρι οι ώμους τους να φθάνουν στον ανώτερο δείκτη ύψους ώμου του βοηθητικού καθίσματος.

Μην χρησιμοποιείτε αυτή την παιδική διάταξη συγκράτησης μέχρι οι ώμοι του παιδιού να είναι πάνω από τον χαμηλότερο δείκτη ύψους ώμων.

Αν τα γόνατα δεν λυγίζουν μπροστά από το μαξιλάρι καθίσματος του οχήματος, συνεχίστε να χρησιμοποιείτε ένα βοηθητικό κάθισμα.

Η χρήση μόνον μίας ζώνης ασφαλείας δεν συνιστάται για παιδιά που έχουν ξεπεράσει αυτό το κάθισμα. Χρησιμοποιήστε ένα μεγαλύτερο συμπληρωματικό κάθισμα.

肩膀超过靠下的肩高标记的儿童（大约6个月的宝宝）采用前向式安装，配备内置安全带使用，直到他们的肩膀超过中间的肩高标记（大约4岁的儿童）。

然后和安全腰带一起使用，直到儿童的肩膀达到靠上的肩高标记（大约6-8岁的儿童）。

可以和此垫高椅匹配的儿童安全带一起使用。

在儿童到达该座椅上限之前必须不断使用该安全座椅。儿童肩膀到达垫高椅靠上的肩高标记以前最安全的办法是使用垫高椅。

在儿童肩膀超过靠下的肩高标记前不得使用该儿童安全座椅。

如果儿童在车辆弹性座垫前无法自然屈膝则需要继续使用垫高椅。

不建议个子比该座椅大的儿童仅仅使用安全带。要使用更大尺寸的垫高椅。

केवल उस शिशु द्वारा बलिट-इन हार्नस के साथ मात्र सामने की दशा की स्थिति में प्रयोग किया जाना चाहिए जिसके कन्धे कन्धे के नचिले भाग से ऊपर आ गए हों (लगभग 6 महीने की आयु पर) और तब तक जब तक कि शिशु के कन्धे कन्धे के ऊपरी भाग के चनिह तक न पहुँच जाएँ (लगभग 4 वर्ष की आयु पर)।

इसके बाद लेप-सेश सीटबेल्ट के साथ तब तक प्रयोग किया जाना चाहिए जब तक कि शिशु के कन्धे कन्धे के ऊपरी भाग के चनिह तक न पहुँच जाएँ (लगभग 6 से 8 वर्ष की आयु पर)।

शिशु हार्नस के साथ प्रयोग भी किया जा सकता है जो बूस्टर सीट मोड में शिशु प्रतबिन्ध के साथ प्रयोग के लिए अनुमोदित हो।

शिशु के इस सीमा तक पहुँचने तक इस शिशु प्रतबिन्ध का प्रयोग जारी रखें। शिशु बूस्टर सीट में तब तक सबसे अधिक सुरक्षित होते हैं जब तक कि उनके कन्धे बूस्टर सीट के कन्धों के ऊपरी चनिह तक न पहुँचें।

शिशु प्रतबिन्ध का प्रयोग तब तक न करें जबतक कि शिशु का कन्धा कन्धे के नचिले भाग के चनिह को पार न करें।

अगर घुटने गाड़ी के सीट के गद्दे पर आगे न मुड़ें तो बूस्टर सीट का प्रयोग जारी रखें।

जनि शिशुओं की आयु इस सीट के लिए उचित आयु से अधिक हो गई हो उनके लिए मात्र सीटबेल्ट के प्रयोग का सुझाव नहीं दिया जाता है।

बड़ी बूस्टर सीट का प्रयोग करें।

INTRODUCTION

Debe utilizarse orientado hacia adelante con un arnés incorporado para un niño cuyos hombros sobrepasen el marcador inferior de la altura de los hombros (aproximadamente a los 6 meses de edad) hasta que sus hombros alcancen el marcador medio de la altura de los hombros (aproximadamente a los 4 años de edad).

Posteriormente debe utilizarse con un cinturón de seguridad de tres puntos hasta que los hombros del niño alcancen el marcador de altura superior (aproximadamente de 6 a 8 años de edad).

También se puede utilizar con el arnés para niños cuyo uso con este sistema de seguridad en el modo de asiento elevador esté aprobado.

Continúe utilizando este sistema de seguridad infantil hasta que el niño alcance dicho límite. El niño estará más seguro en un asiento elevador hasta que sus hombros alcancen el marcador de altura superior del asiento elevador.

No utilice este sistema de seguridad hasta que los hombros del niño no sobrepasen el marcador de altura inferior.

Si las rodillas del niño no se doblan en la parte delantera del cojín del asiento del vehículo siga utilizando un asiento elevador.

No se recomienda utilizar sólo un cinturón de seguridad para el niño que ya no quepa en este asiento. Utilice un asiento elevador más grande.

適用肩膀超過靠下的肩高標記的孩子（大於6個月大），作為前向式安全座椅與內建式安全帶一並使用，直至其肩膀達到中間的肩高標記（大約4歲大）。

然後同安全腰帶一並使用，直至孩子肩膀達到靠上的肩高度標記（大約6至8歲大）。

也可同與此墊高椅匹配的兒童安全背帶一並使用。

請讓您的孩子一直乘坐此安全座椅，直至其達到座椅的上限。孩子肩膀到達靠上的肩高標記之前，使用墊高椅是最安全的做法。

孩子肩膀超過靠下的肩高標記之前，切勿使用此座椅。

若孩子在汽車座椅邊無法自然曲膝，請繼續使用墊高椅。

孩子因長大超出墊高椅的上限時，不推薦僅僅使用安全帶。推薦使用更大尺寸的墊高椅。

INTRODUCTION

Magagamit lamang sa isang nakaharap pasulong na posisyon na may kasamang guwarnisyon ng isang bata na ang mga balikat ay lampas sa ibabang marka ng taas ng balikat (humigit-kumulang 6 na buwang edad) hanggang sa maabot ng kanilang mga balikat ang gitnang marka ng taas sa balikat (humigit-kumulang 4 na taong gulang).

Pagkatapos ay magagamit kasama ang isang lap-sash na seatbelt hanggang sa maabot ng mga balikat ng bata ang itaas na marka ng taas ng balikat (humigit-kumulang 6-8 taong gulang).

Maaari ring gamitin kasama ang guwarnisyon ng bata na naaprubahang gamitin sa pampigil ng bata na ito sa modang upuang booster.

Patuloy na gamitin ang pampigil sa bata na ito hanggang sa maabot ng bata ang limitasyong ito. Ang mga bata ay pinakaligtas sa isang upuang booster hanggang sa maabot ng kanilang mga balikat ang itaas na marka ng taas ng balikat ng upuang booster.

Huwag gamitin ang pampigil sa bata na ito hanggang sa ang mga balikat ng bata ay lumampas sa ibabang marka ng taas ng balikat.

Kung ang mga tuhod ay hindi makaliko sa harap ng kutson ng upuan ng sasakyan ay patuloy na gamitin ang upuang booster.

Ang paggamit lamang ng seatbelt ay hindi inirerekomenda para sa mga bata na nakalakhan na ang upuang ito. Gumamit ng mas malaking upuang booster.

Da utilizzare nella posizione del senso di marcia con imbracatura interna da un bambino le cui spalle sono al di sopra del marcatore di altezza inferiore (circa 6 mesi di età) fino a quando le spalle raggiungono il marcatore di altezza centrale (circa 4 anni di età).

Dopo di che utilizzare con una cintura di sicurezza fasciante fino a quando le spalle del bambino raggiungono il marcatore di altezza superiore (circa 6 a 8 anni di età).

Può essere utilizzato anche con imbracatura del bambino approvata per l'uso con questo sistema di ritenuta in modalità seggiolino.

Continuare a utilizzare questa ritenuta per bambini fino a quando il bambino raggiunge questo limite. I bambini sono più sicuri in un seggiolino fino a che le loro spalle raggiungono il marcatore di altezza superiore del seggiolino.

Non utilizzare il seggiolino fino a quando le spalle del bambino sono al di sopra del marcatore di altezza inferiore.

Se le ginocchia non si piegano al limite del sedile del veicolo continuare ad utilizzare un seggiolino.

Usare soltanto la cintura di sicurezza non è raccomandato per i bambini che sono troppo grandi per questo sedile. Utilizzare un seggiolino più grande.

INTRODUCTION

Carefully read all the instructions for installation in this book. If in doubt about the method of installation, consult BabyLove® or agent or a child restraint fitting station authorized by a relevant transport authority or, in New Zealand, the agent for the vehicle or authorized child restraint fitter.

THIS RESTRAINT MUST BE ATTACHED TO A CHILD RESTRAINT UPPER ANCHORAGE POINT IN THE CAR. REFER TO CAR OWNER'S HANDBOOK FOR LOCATION OF UPPER ANCHORAGE POINTS. REFER TO A CHILD RESTRAINT FITTING STATION IF NO UPPER ANCHORAGE POINTS ARE IN THE MOTOR CAR. Refer to pages 69 to 72.

WHEN USED WITH IN-BUILT HARNESS:

TO BE USED WITH A LAP-SASH OR LAP ONLY SEATBELT IN THE BACK OF MOST CARS WITH FORWARD FACING SEATS.

WHEN USED AS A BOOSTER SEAT:

THIS RESTRAINT MUST BE USED IN CARS WITH FORWARD-FACING SEATS WITH A LAP-SASH SEATBELT. THIS BOOSTER SEAT IS NOT SUITABLE FOR USE WITH A CHILD HARNESS.

No child restraint can guarantee absolute protection from injury in every crash. However, to ensure that your child gets all the protection designed into the restraint PLEASE READ AND FOLLOW THESE INSTRUCTIONS EXACTLY and use only BabyLove® recommended parts and accessories.

Always store the instruction book in the pocket provided on the side or the back of the cover.

Regional Road Rules may prohibit the use of a restraint in the front seat until the child is 4 years of age.

Check your Regional Rules for exemptions.

- 10** INTRODUCTION
- 12** WARNINGS
- 14** SHOULDER HEIGHT MARKERS
 - A GROWING CHILD
 - THE NEXT STEP
- TODDLER USE (WITH IN-BUILT HARNESS)
- 18** FEATURES
- 20** SUITABLE FOR USE
- 21** HOW TO SETUP
- 25** HOW TO INSTALL
- 29** HOW TO USE
- 31** HOW TO REMOVE
- CHILD USE (BOOSTER MODE WITH SEATBELT)
- 32** FEATURES
- 34** SUITABLE FOR USE
- 35** HOW TO SETUP
- 42** HOW TO INSTALL
- 46** HOW TO USE
- 48** CONVERSION TO INBUILT HARNESS USE
- CARE & MAINTENANCE
- 49** CARE AND MAINTENANCE
- 53** ACCESSORIES AND FEATURES
- 57** INSTALLATION OF CAR UPPER ANCHORAGE FITTING
- 61** IN CASE OF CRASH
- WARRANTY



WARNINGS

WHEN USED WITH THE 'BUILT-IN' HARNESS

- Fit the restraint firmly to the car seat.
- Fit the harness firmly to the child.
- A loose restraint or harness is dangerous.
- When used in this mode the restraint must be fitted to the car with a lap or lap-sash seatbelt.

AS A BOOSTER SEAT

- DO NOT USE WITH JUST A LAP BELT. You must use with a lap-sash seatbelt.
- The lap part of the seatbelt must be firmly across the thighs and the sash belt fitted diagonally across the chest and on the shoulder.
- Do not use the integral harness in booster mode. The built-in harness must be stored. Use the vehicle lap-sash seatbelt with top tether.

GENERAL WARNINGS

- Supervision of children is needed because they may be able to undo the buckles and adjusters.
- Use the restraint exactly as shown in the instructions.
- Do not alter or modify this restraint.
- Repairs must only be done by the manufacturer or agent. Use only recommended parts and accessories.
- Do not allow the restraint to come into contact with polishes, oils, bleach and other chemicals.
- Destroy the restraint if it has been in a severe crash, even if no damage is visible.
- DO NOT USE THIS RESTRAINT WITHOUT THE COVER.
- This child restraint is not approved for use with any connectors that connect to the car's ISOFIX low anchorages.
- Always secure the loose end of the top tether strap. Do not use the child restraint where this strap may fall into a split in the seat back or off the side of the seat.
- **DO NOT LEAVE CHILDREN UNATTENDED IN THE CAR.**



IMPORTANT:

- Regularly check the restraint components, straps and other fitments for correct function and condition. Seek prompt repair.
- IF AN AIRBAG IS FITTED IN THE SEATING POSITION WHERE THE CHILD RESTRAINT IS TO BE FITTED, FOLLOW THE VEHICLE MANUFACTURERS WARNINGS AND INSTRUCTIONS.
- Protect all webbing from abrasion and cutting by sharp corners and edges.
- The restraint should not be purchased or sold as a second hand item. It is recommended not to use child restraints older than 10 years as the protection in an accident may be reduced.
- THIS RESTRAINT IS NOT SUITABLE FOR USE WHERE THE TOP TETHER STRAP MAY FALL INTO A SPLIT IN THE SEAT BACK OR OFF THE SIDE OF THE SEAT.
- Seatbelt extenders are not recommended to be used if the seatbelt is not long enough to secure the child restraint. If seatbelts are too short then seek advice from a child restraint fitter and consider their recommendations before using a seatbelt extender. If you use a seatbelt extender then ensure that the seatbelt buckle does not contact the child.
- Do not store in areas that may get hot, like in car boots, roof space, beside shed walls which get hot in summer. Do not place heavy items on top of the seat as this may distort the plastic

SHOULDER HEIGHT MARKER

 **IMPORTANT: Follow this advice.**

Marker A Smaller Toddler - LOWER SHOULDER HEIGHT MARKER

Using the in-built harness, the child's shoulders must be in-line with this marker or above this marker. If the child's shoulders are below then the child should remain in their previous child restraint. Approx 6 months of age.



Marker B Larger Toddler - MIDDLE SHOULDER HEIGHT MARKER

When the child's shoulders reach this marker, convert the child restraint to booster seat mode and use a lap-sash seatbelt. Approx 4 years old.

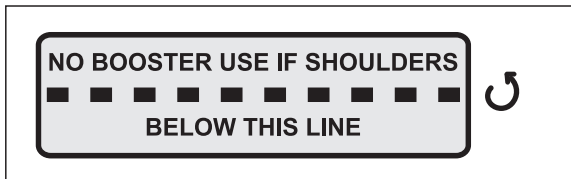

Marker C Larger Child - UPPER SHOULDER HEIGHT MARKER

When the child's shoulders reach this upper marker, or the child no longer fits in the child restraint, approx 6 to 8 years of age, then the child must be moved to the next form of child restraint, see next page.

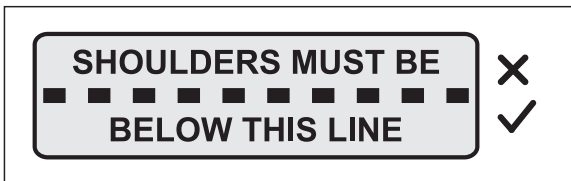

SHOULDER HEIGHT MARKERS & A GROWING CHILD

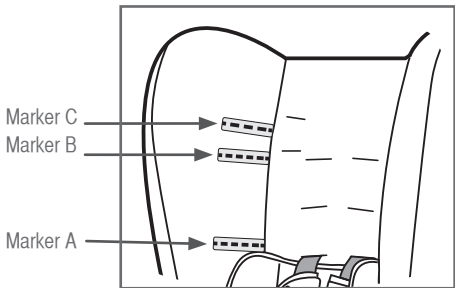

YOUNG TODDLER

Shoulders must not be below the lowest marker. Use the in-built harness.

From approximately 6 months of age.

However, Britax recommends to keep your child in a rearward facing restraint for as long as possible (up to approx 12 months) until the neck muscles are able to support the head.



OLDER TODDLER

When shoulders are in-line with middle marker, Change to Booster Seat mode.

From approximately 4 years of age.

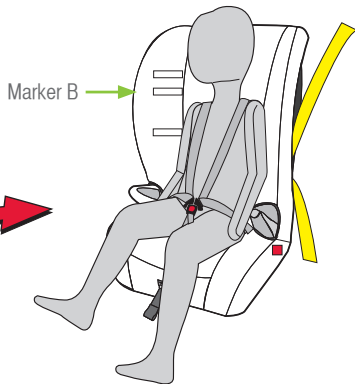

SHOULDER HEIGHT MARKERS & A GROWING CHILD

OLDER CHILD

AS A BOOSTER SEAT WITH LAP SASH SEATBELT

To approximately 6 - 8 years of age.

Shoulders above middle marker but below upper shoulder height marker.

When your child's shoulders reach the upper shoulder height marker, they have outgrown this child restraint.

Change to the next type of booster seat or child restraint.



Front of Vehicle

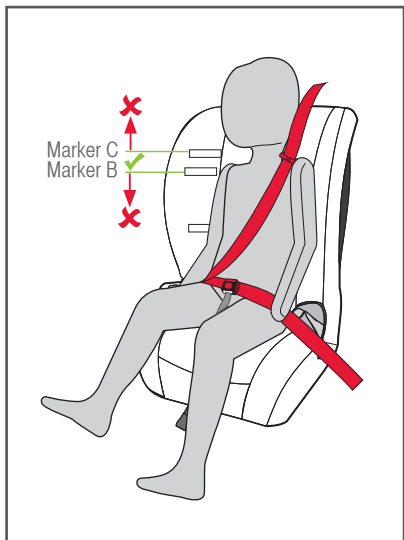

SHOULDER HEIGHT LABELS & THE NEXT STEP

OLDER CHILD

WHICH RESTRAINT CAN YOU USE NEXT?

When your child has outgrown the seat, you can:

- A. Use a booster seat suitable for children up to 8-10 years of age with the car's seatbelt.*

OR

- B. A child may use the vehicle seat and seatbelt without a booster seat if the child's legs hang over the seat edge.

Otherwise if the child's legs do not hang over the edge of the vehicle seat then they need to use a booster seat so that the seatbelt fits correctly and so the child does not slump.

A lap seatbelt on the child's abdomen is dangerous.

NOTE: This child restraint includes a booster seat configuration for children 4 years to approximately 6 to 8 years.

*For more information on suitable booster seats visit www.babylove.com.au or www.britax.com.au

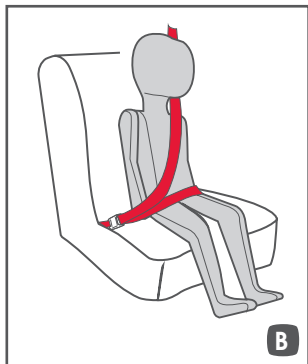
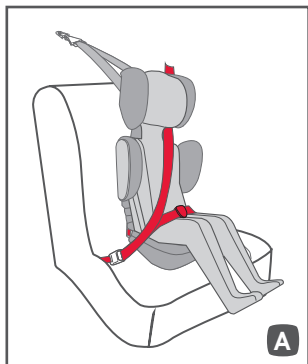

FEATURES

TODDLER USE

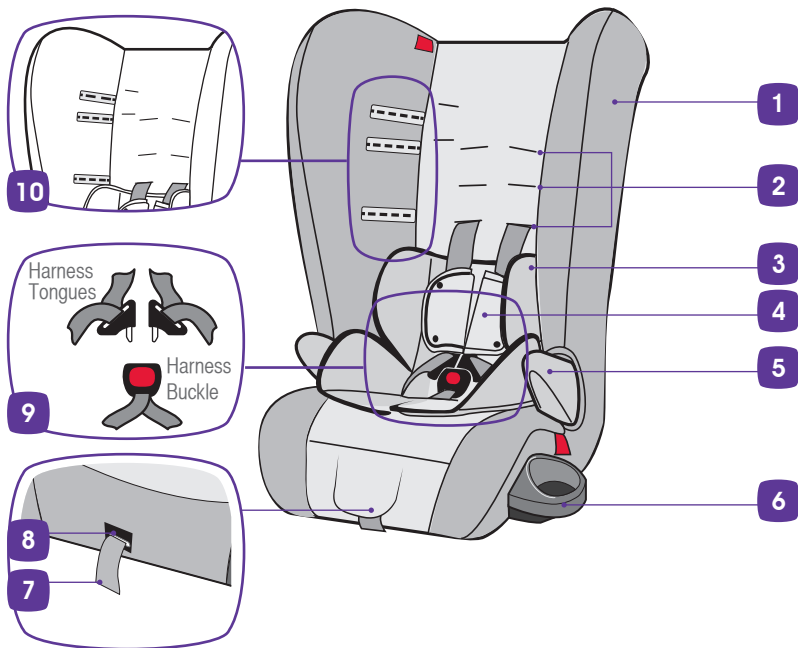

1. Padded cover for comfort
2. Harness Slots (Toddler Mode)
3. Padded Insert (if fitted)
4. Shoulder Pads (if fitted)
5. Armrests
6. Cup Holder (if fitted)
7. Harness Adjuster Strap
8. Harness Adjustment Lever
9. Quick Release Harness Buckle (red button)
10. Shoulder Height Markers

FEATURES

TODDLER USE

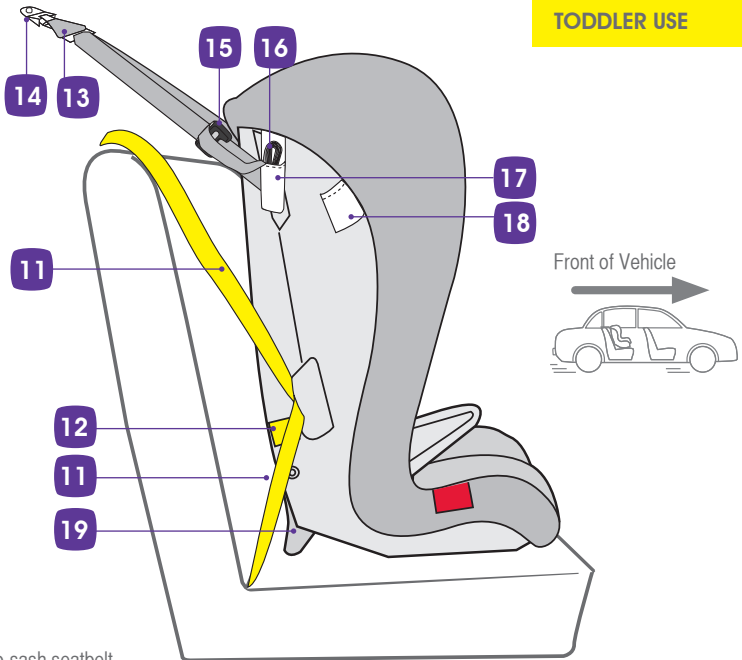

- 11. Vehicle Lap-sash seatbelt
- 12. Yellow **FORWARD FACING BELT PATH** labels
- 13. Attachment Clip
- 14. Car's Upper Anchorage Fitting
- 15. Top Tether Strap Adjuster
- 16. Top Tether Strap.
- 17. Top Tether Storage Pocket (attached to cover)
- 18. Instruction Book Storage Pocket (either side)
- 19. Adjustable Recline Foot

NOTE: Not all features are supplied on some models. "if fitted" is used to indicate some of the features that may not be on the seat supplied.

SUITABLE FOR USE

TODDLER USE

For a toddler whose shoulders are above the lower shoulder height marker, use with the integrated harness (from approx 6 months of age).

Continue to use this child restraint with harness until the shoulders reach the middle shoulder height marker.

Children are at risk of serious injury if they move to booster seats too early.

The child should not sit in this forward facing child restraint until their neck muscles are able to support their head. BabyLove® recommends that you keep your child in a rearward facing restraint for as long as possible (up to approx 12 months).

This child restraint uses a top tether strap in a vehicle seating position with a child restraint upper anchor fitting or anchorage point. If there is no anchor fitting see pages 69 to 72.

TO BE USED WITH A LAP SASH OR LAP ONLY SEATBELT IN THE BACK OF MOST CARS WITH FORWARD-FACING SEATS.

HOW TO SETUP

TODDLER USE

ADJUSTING SHOULDER HARNESS STRAPS HEIGHT

Correct fitment of the harness is very important as it restrains the child in the restraint. The harness must fit firmly around the upper torso of the child and be positioned so as to leave the child's arms and legs free.

Adjust the shoulder straps so that they are just above the shoulders. See the next page.

1. Upper shoulder strap slots
2. Middle shoulder strap slots
3. Lower shoulder strap slots
4. Shoulder harness straps
5. Lap straps
6. Harness tongues and buckle
7. Crotch Straps
8. Harness adjustment strap
9. Shoulder Height Markers

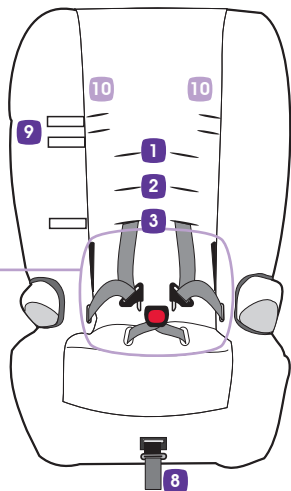
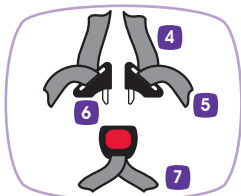

BOOSTER MODE ONLY

10. Sash Guide Slots

The shoulder straps must be in the slots which are nearest to the child's shoulders, but not more than 25mm below the child's shoulders.

NOTE: If child's shoulders touch the head pillow (if fitted), adjust the head pillow up to the next position.

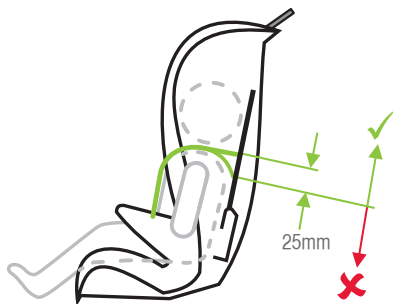

HOW TO SETUP

TODDLER USE

SETTING UP THE HARNESS

- Position the restraint on flat ground, supported from behind so that it will not tip over.
- Sit the child comfortably in position.
- Determine the desired shoulder strap position.
- Remove the child and adjust the shoulder straps using the following methods.

ADJUSTING THE BUCKLE POSITION

The Child restraint is supplied with the crotch straps set at the correct position for use with the built-in harness.

The buckle needs to be positioned as shown. If the buckle is too low it will be uncomfortable and should be lengthened. See page 24.

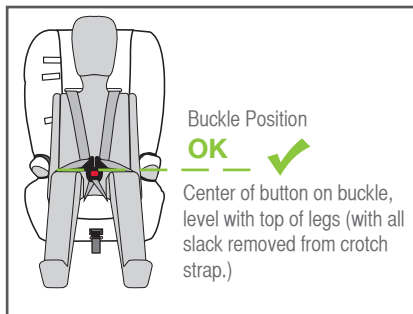

IMPORTANT:

You must adjust the crotch strap to the correct length for your child before installing the restraint as it cannot be adjusted in the car. The crotch strap should only be extended if the harness tongues are located low against your child's legs, thus creating discomfort.

Always return the crotch strap to its shorter length when using the seat with a smaller child.

The buckle should always be positioned low, near to the hips.

DO NOT attempt to remove the crotch strap from the adjuster. Adjustment is made by feeding the crotch strap through the adjuster as shown on the next page and does not need to be removed from the seat.

HOW TO SETUP

TODDLER USE

STEPS IN CHANGING SHOULDER STRAP SLOTS

- Disengage harness buckle. Fully lengthen the harness by pressing the Harness Adjustment lever and pulling the harness shoulder straps.
- At the rear of the restraint, remove one of the harness shoulder straps from metal strap connector (shown) by slipping strap through open slot.
- From the front of the seat remove the shoulder strap through the shoulder slot.
- Insert shoulder strap through a restraint slot which will position shoulder strap level with or above the child's shoulder. Ensure that the shoulder strap passes through matching slots in cover and restraint body.
- Ensure there are no twists in the harness strap and the buckle tongues face the correct way.
- Connect shoulder strap to metal strap connector at rear of restraint.
- Repeat for other shoulder strap. It is better to change one strap at a time so that the other strap will be a guide for re-assembly.

IMPORTANT:

Do not use the restraint with harness shoulder straps set at different heights or fed through mismatching slots. Ensure harness straps are not twisted and that all straps are secure by pulling each harness strap.

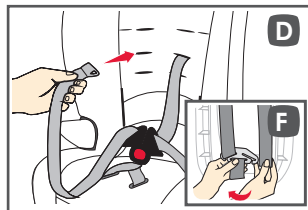
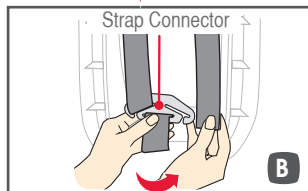
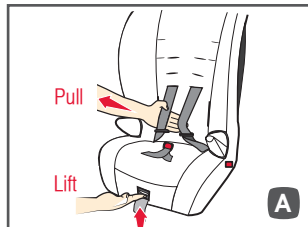

HOW TO SETUP

TODDLER USE

ADJUSTING THE CROTCH BUCKLE HEIGHT

Buckle height adjustment is changed by threading the anchor plates into the respective slot as shown below. The centre of the buckle should be positioned approximately in line with top of the thighs.

The seat has the crotch straps fitted in the longest position when supplied, these may be adjusted to suit your child if necessary.

Use Position 1 for smaller children and Position 2 and 3 for larger children.

- Lift trim cover to reveal crotch strap slot.
- Turn the anchor plate and push through the slot as shown until the strap assembly is free from the seat.
- Insert anchor plates through restraint slots which will position the buckle at approximately thigh level (as shown). The buckle must not be positioned on the child's abdomen.

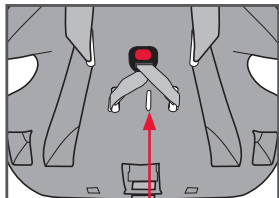

3 Crotch strap slots

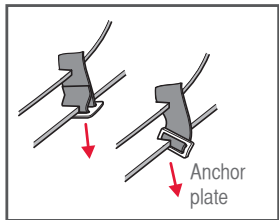

1. Shortest Length
for smaller child

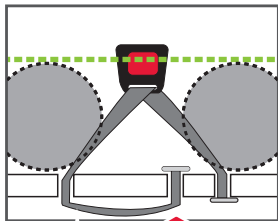

2. Mid Length
for mid size Child

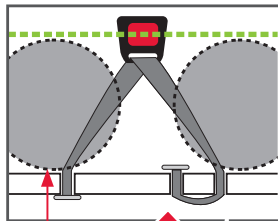

3. Longest Length
for larger child.

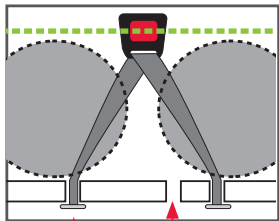

Child's leg

Anchor plate

Slot



IMPORTANT:

When replacing cover, ensure none of the harness straps are twisted and that all straps are secure by pulling each harness strap.

HOW TO INSTALL

TODDLER USE

INSTALLING INTO VEHICLE (FORWARD-FACING) (UPRIGHT OR RECLINED)

Determine whether an upright or reclined installation is preferred as shown below.

- A. For upright mode, rotate the foot backwards until it clicks into position.
- B. For reclined mode, rotate the recline foot forwards until it is under the restraint.

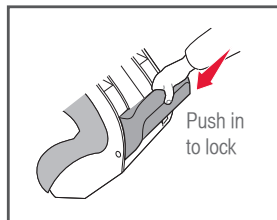
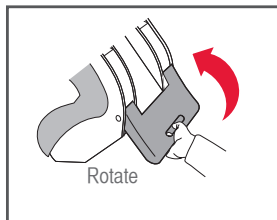
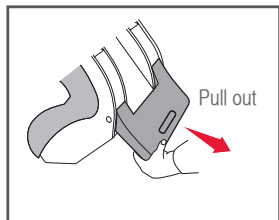
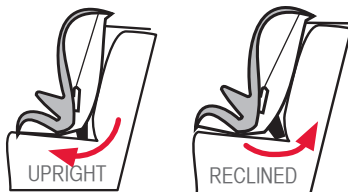

HOW TO INSTALL

TODDLER USE

C. Position restraint centrally to the chosen vehicle seat position and forward facing.

Some vehicle seat fabrics (particularly velours) may be damaged by a child restraint used continuously. We recommend the use of a Messy Mat (if supplied) or other protection under and behind the seat to keep the vehicle seat in good condition.

Fully lengthen seatbelt and feed the seatbelt through the closest seatbelt path slot and across the seating surface through the opposite slot. Follow the yellow belt path label - **FORWARD-FACING BELT PATH** and engage the seatbelt tongue into the buckle and remove all slack.

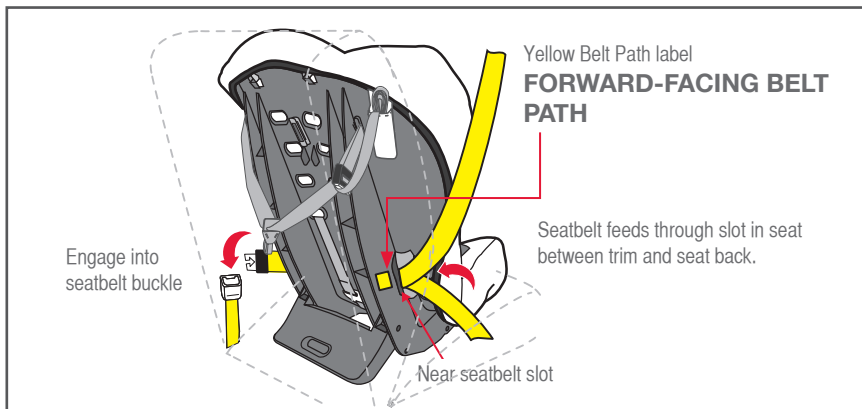

HOW TO INSTALL

TODDLER USE

- D. Push down on the restraint to compress it into the vehicle seat. Whilst compressed in the seat, pull on the lap portion to remove all slack from the belt. Pull the sash belt and allow excess belt to feed back into the retractor. Ensure all slack is removed from the lap and sash belt.
- E. The restraint should be held firmly against the vehicle seatback.
- F. Lengthen the top tether strap and fit the attachment clip on the upper anchorage strap to the anchor fitting as shown. Make sure to remove as many twists as possible from the upper anchorage strap.

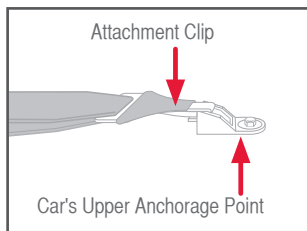
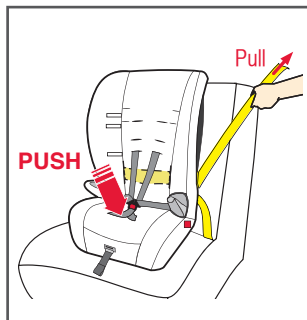

WARNING

Always attach the hook and remove slack

HOW TO INSTALL

TODDLER USE

- G. Tighten adjustable top tether strap by pulling adjustment strap to remove slack as shown below, but do not over-tighten causing the restraint base to lift off the vehicle seat.
- H. Fold up excess strap and use the top tether pocket to store excess strap behind seat in the pocket provided.

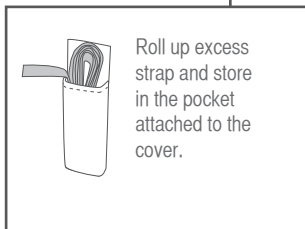
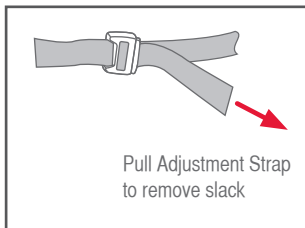

IMPORTANT:

Always ensure that the car seatbelt is firmly restraining the child restraint on the vehicle seat and ensure the slack is removed from the tether strap.

Always secure the loose end of the top tether strap to prevent it hanging out of the car or being accessible by the child. Do not use the child restraint where this strap may fall into a split in the seatback or off the side of the seat.

Make sure cup holders (if fitted) do not interfere with closure of the car door.

ALWAYS ATTACH TOP TETHER HOOK AND REMOVE SLACK.



CAUTION:

CHILDREN CAN BE INJURED OR RESTRAINTS AND TOP TETHER STRAP DAMAGED BY UNSECURED CARGO IN A COLLISION. SECURE OR REMOVE HAZARDOUS CARGO BEFORE USING THIS CHILD RESTRAINT.

HOW TO USE

TODDLER USE

PLACING TODDLER IN THE RESTRAINT

- A. Ensure the shoulder straps are adjusted to the correct height for your child (see page 21). Loosen shoulder straps by lifting the harness adjuster and pull both shoulder straps evenly. Pull out the desired amount of slack. Place the two harness tongues into the Buckle Tongue Holder (if fitted). Move the harness buckle towards the harness adjuster for easier fitment next time you put the infant in the carrier.
- B. Place toddler in the restraint and feed each arm through the shoulder straps. Pull harness buckle up between child's legs.

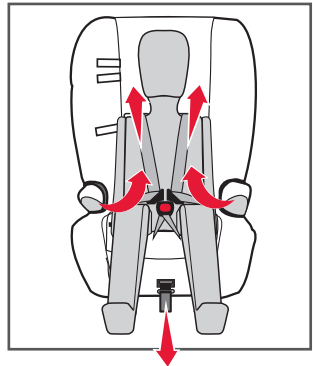
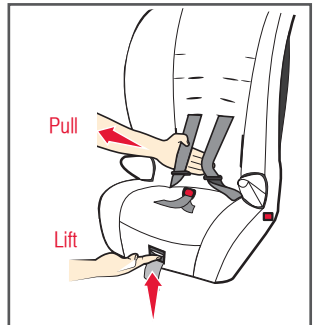

IMPORTANT:

Always adjust the height of the shoulder straps as the child grows.

HOW TO USE

TODDLER USE

- C. Fit either harness tongue into the harness buckle followed by the other tongue. A click is heard when the last tongue is fully engaged. Should the second tongue not engage - press the red button and reinsert the tongues. Ensure secure engagement by pulling harness straps. If the harness buckle does not engage correctly then it may require cleaning or seek replacement - refer to page 62. **The buckle tongues are fully engaged when both tongues are inserted and 'click' is heard.**
- D. Ensure slack is removed from harness lap strap by pulling shoulder straps then pull harness adjustment strap to adjust harness to a comfortable but firm fit. Ensure that any slack in harness straps is removed. Shoulder harness straps must fit firmly to the child. A loose harness could result in serious injury in an accident.

Do not use the restraint if straps do not tighten. Contact your local authorised service agent for repair.

Store instruction manual in pocket provided and tuck pocket under trim cover.

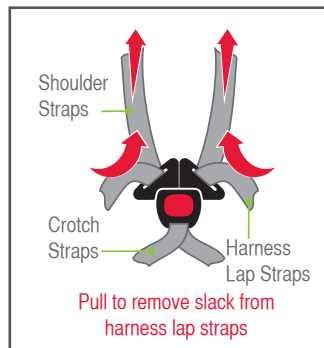
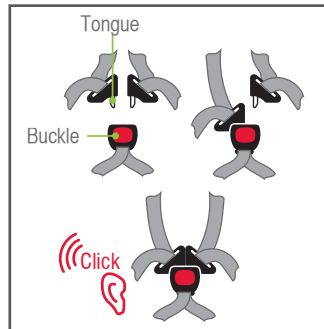

WARNING:

DO NOT LEAVE CHILDREN UNATTENDED IN THE CAR.



CAUTION: A LOOSE HARNESS IS DANGEROUS.

Make sure that nothing is obstructing harness straps and that child's arms and legs are free with the straps in the correct location - see previous page.

Do not use the restraint if straps do not tighten and contact BabyLove® Customer Service. Refer to back cover for contact details.

HOW TO REMOVE

TODDLER USE

TO REMOVE CHILD FROM RESTRAINT

Press the red harness buckle button, both harness tongues will be released. You may lengthen the harness by pressing the adjuster button or lifting the adjuster lever and pulling the shoulder straps. Move each shoulder strap to the child's side, remove the child. If buckle tongue holders are provided, store the tongues in these.

TO REMOVE RESTRAINT FROM VEHICLE

- Disengage seatbelt tongue from buckle and remove from restraint.
- Fully press top tether strap adjuster button (A) while pulling top tether strap (B) to slacken as shown right. In some vehicles loosening of the top tether strap may be difficult. If so, try pushing the restraint against the vehicle seat back or slightly lifting the restraint to release the tension.
- Disengage the attachment clip from the car's upper anchorage point. The child restraint is now disconnected and can be removed from the car.

Fully press adjuster button (A) while pulling top tether strap (B) to lengthen.

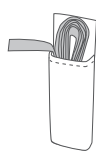
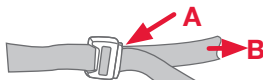

Roll up excess strap and store in the pocket attached to the cover to avoid tripping when moving the restraint.

FEATURES

BOOSTER MODE WITH SEATBELT

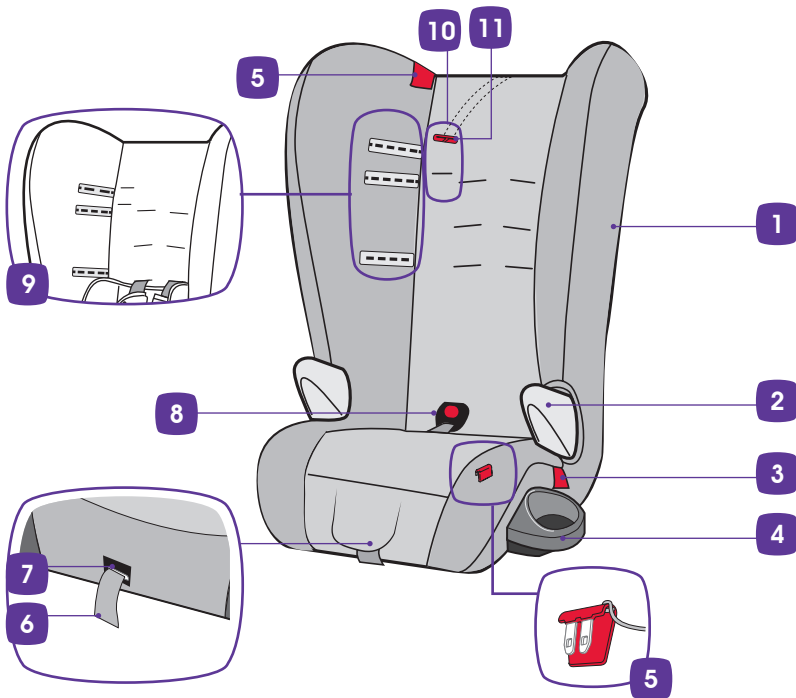

1. Padded cover
2. Armrests
3. Red **BOOSTER SEATBELT PATH** labels
4. Cup Holder (if fitted)
5. Lap belt SecureGuard™ device (Stored, see page 34)
6. Harness Adjuster Strap
7. Harness Adjustment Lever
8. Harness Buckle
9. Shoulder Height Markers
10. Sash Guide Slots (seatbelt)
11. Sash Guide (in top position)

FEATURES

BOOSTER MODE WITH SEATBELT

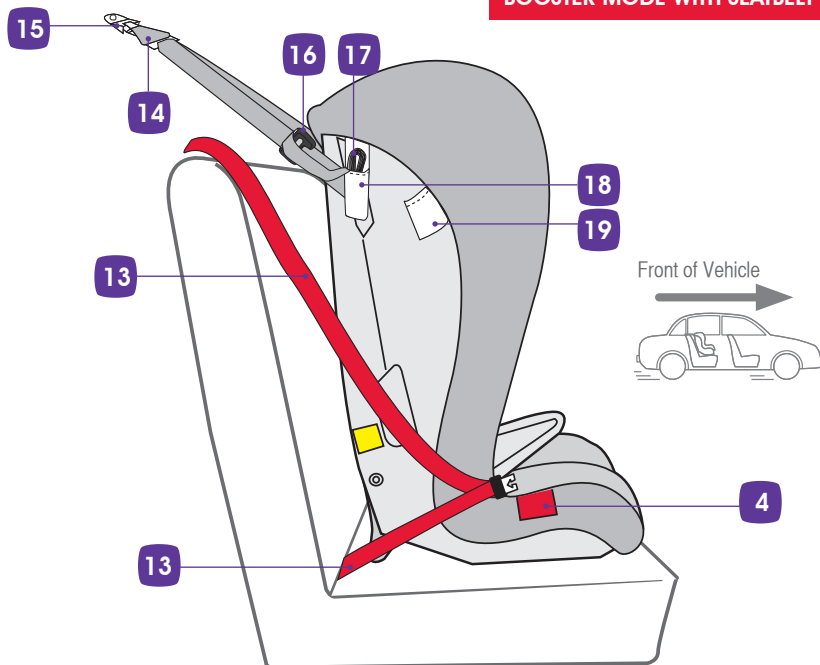

- 13. Vehicle Lap-sash seatbelt
- 14. Top Tether attachment clip
- 15. Car's Upper Anchorage Fitting
- 16. Top Tether Strap Adjuster
- 17. Top Tether Strap.
- 18. Top Tether Storage Pocket (attached to cover)
- 19. Instruction Book Storage Pocket.

NOTE: Not all features are supplied on some models. "if fitted" is used to indicate some of the features that may not be on the seat supplied.

SUITABLE FOR USE

BOOSTER MODE WITH SEATBELT

For a child whose shoulders have reached the middle shoulder height marker (approx 4 yrs old), convert the seat to booster mode. Use as a booster seat with the vehicle lap sash seatbelt until your child's shoulders reach the upper shoulder height marker.

This child restraint uses a top tether strap in a vehicle seating position with a child restraint upper anchor fitting or anchorage point. If there is no anchor fitting see pages 57 to 60.

Children are safest travelling in a Booster Seat until their shoulders have reached the upper shoulder height marker of the Booster Seat.

THIS RESTRAINT MUST BE USED IN CARS WITH FORWARD-FACING SEATS WITH A LAP-SASH SEATBELT. THIS BOOSTER SEAT IS NOT SUITABLE FOR USE WITH A CHILD HARNESS.

HOW TO SETUP

BOOSTER MODE WITH SEATBELT

CONVERTING THE TODDLER RESTRAINT INTO BOOSTER MODE

To use this child restraint as a booster seat the harness needs to be stored under the cover.

Disengage and remove the seatbelt from the restraint.

You will need to remove the upper anchorage strap from the anchor fitting when converting to a booster seat.

Upper anchorage strap must always be used in the booster position when re-installed.

If fitted, remove all comfort accessories from the restraint.

CHILD USE WITH SecureGuard™ DEVICE

The SecureGuard™ device is found in a storage recess under the cover, as shown below and is connected to the buckle to form the SecureGuard™ device.

Place rolled-up Harness strap and Harness Tongue in recess

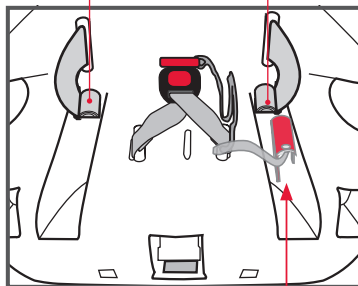

SecureGuard™ device storage location

HOW TO SETUP

BOOSTER MODE WITH SEATBELT

STORING THE HARNESS

- A. Disengage harness buckle. Fully lengthen the harness by pressing the Harness Adjustment lever and pulling the harness shoulder straps.
- B. At the rear of the restraint, remove both harness shoulder straps from metal strap connector (shown) by slipping strap through open slot.
- C. Pull the shoulder straps through slots in the seat back.
- D. Remove the elastic loops holding the cover in place at the lower front of the seat. Lift the cover to expose the storage inserts in the seat base.
- E. Feed the straps with harness tongues through the bottom rear of the seat cover. Roll up each harness strap with harness tongue and place into the left and right rear recess in the seat base (underneath the cover).

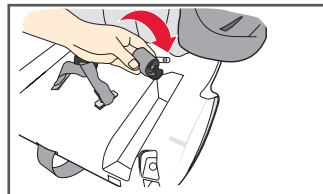
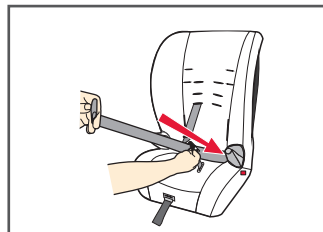
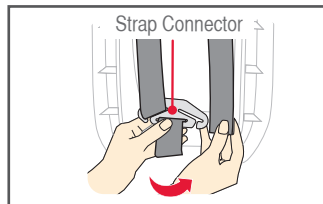
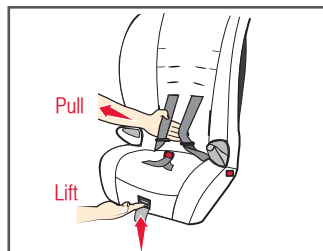

HOW TO SETUP

BOOSTER MODE WITH SEATBELT

- F. Remove SecureGuard™ device from storage recess and engage into harness buckle.
- G. Adjust the crotch strap length if necessary. See page 39.
- H. Replace cover and re-attach elastic loops at the front of the cover to the child seat.

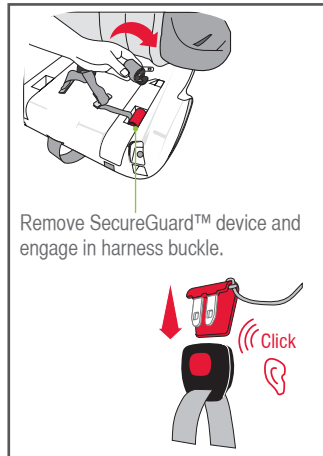

- I. Extend and roll up the harness adjustment strap and metal strap connector, then store inside the recline foot.
- J. Store shoulder pads (if fitted) in a safe place, for future use.

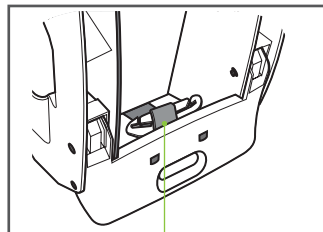

Store metal connector in recline foot

HOW TO SETUP

BOOSTER MODE WITH SEATBELT

ADJUSTING THE SecureGuard™ DEVICE POSITION

IMPORTANT:

The SecureGuard™ device ensures that the child does not slump and ensures the lap belt is always positioned on the child's hips and thighs. If the seatbelt rides up onto the stomach then a child can be seriously injured in a crash. To adjust buckle height, see page 39. You must adjust the crotch strap to the correct length for your child before installing the restraint as it cannot be adjusted with the child seated.

The crotch strap should only be extended if the buckle and SecureGuard™ device are located too low against your child's legs, causing discomfort.

Always return the crotch strap to its original shorter length when using the seat with a smaller child.

The buckle and SecureGuard™ device should always be positioned low down on your child's body.

- Sit the restraint against a wall for stability and get the child to sit comfortably in position.
- Determine the correct buckle position. The centre of the buckle needs to be level with the top of the legs.

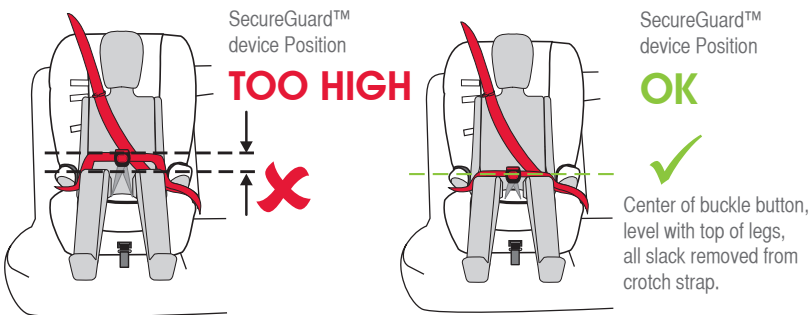

- Remove the child and adjust the buckle strap length as on page 39.



IMPORTANT:

ALWAYS USE THE SecureGuard™ DEVICE

HOW TO SETUP

BOOSTER MODE WITH SEATBELT

ADJUSTING THE SecureGuard™ DEVICE BUCKLE HEIGHT

Adjust the SecureGuard™ device height by re threading the anchor plates into other slots in the seat shell. The seat has the crotch straps fitted in the longest position when supplied. Adjust the height to position the lap strap on the hips and thighs.

- Lift trim cover to reveal crotch strap slot (see page 37).
- Turn the anchor plate and push through each slot as shown until the strap assembly is free from the seat.
- Insert anchor plates through restraint slots which will position the lap strap level with the child's thighs. The SecureGuard™ device must not be positioned on the child's abdomen.

Use Position 2 for smaller children and Position 1 and 3 for larger children.

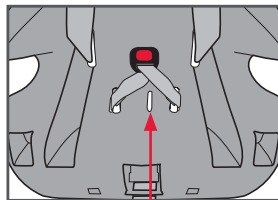

3 Crotch strap slots

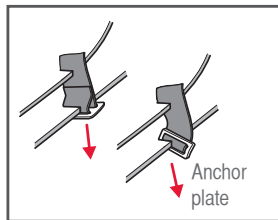

Anchor plate

1. Shortest Length
for smaller child

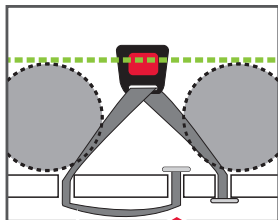

2. Mid Length
for mid size Child

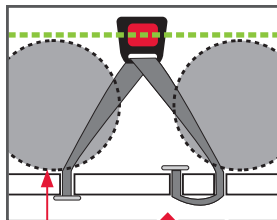

Child's leg

3. Longest Length
for larger child

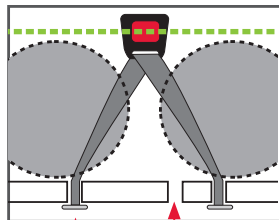

Anchor plate Slot



IMPORTANT:

When replacing cover, ensure none of the harness straps are twisted and that all straps are secure by pulling each harness strap.

HOW TO SETUP

BOOSTER MODE WITH SEATBELT

FOR USE WITH VEHICLE SEATBELT SETTING UP THE SASH GUIDE

- A. Determine the correct height for sash guide.
- B. Unhook the elastic loops at the top rear of the restraint, then pull the cover forward to reveal the sash guide which is attached to a strap at the back of the seat cover.
- C. Fit the sash guide through the sash guide slot of the cover then refit the cover.

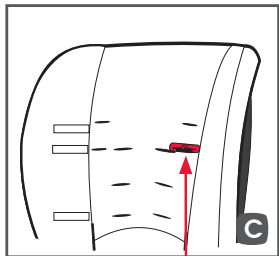
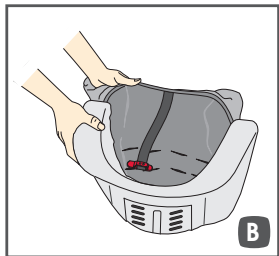

Thread the sash guide
through the chosen slot
in the seat cover

HOW TO SETUP

BOOSTER MODE WITH SEATBELT

- D. The sash guide should be located just above the child's shoulders.
The sash guide must be used to position the sash portion of the lap-sash seatbelt across the child's shoulders and chest. Choose the sash guide slot nearest to, but above the shoulder height of the child.

Adjust the sash guide so that it positions the sash belt over the chest and the front of the shoulder. Do not over tighten.

To Lengthen

Hold the strap, rotate and pull the sash guide to lengthen

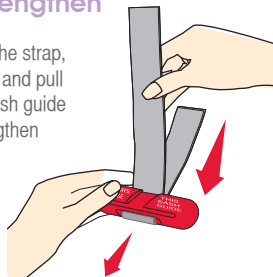

To Shorten

Hold the Sash Guide and pull strap to shorten

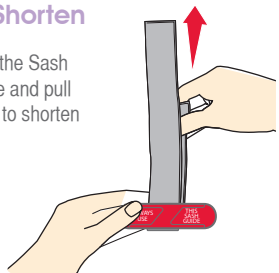

IMPORTANT:
ALWAYS USE THE SASH GUIDE

HOW TO INSTALL

BOOSTER MODE WITH SEATBELT

INSTALLING INTO VEHICLE (FORWARD-FACING) (UPRIGHT OR RECLINED)

Determine whether an upright or reclined installation is preferred as shown below.

- For upright mode, rotate the foot backwards until it clicks into position.
- For reclined mode, rotate the recline foot forwards until it is under the restraint.

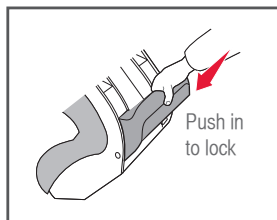
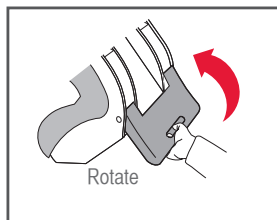
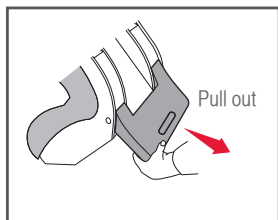
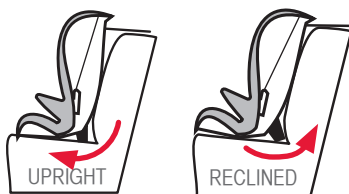

- Lengthen the top tether strap and fit the attachment clip on the upper anchorage strap to the anchor fitting as shown. Make sure to remove as many twists as possible from the upper anchorage strap.

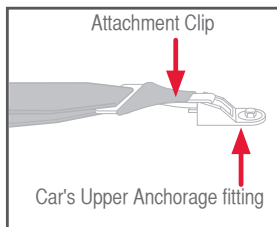

HOW TO INSTALL

BOOSTER MODE WITH SEATBELT

- D. Tighten adjustable top tether strap by pulling adjustment strap to remove slack as shown below, but do not over-tighten causing the restraint base to lift off the vehicle seat.
- E. Fold up excess strap and use the top tether pocket to store excess strap behind seat away from child's reach.



WARNING

Always attach the hook and remove slack

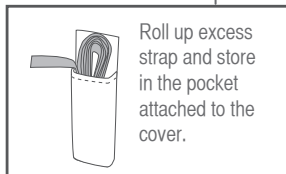
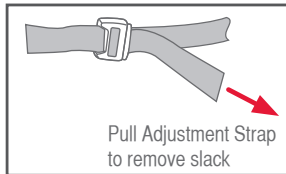

IMPORTANT:

Always ensure the slack is removed from the tether strap.

Always secure the loose end of the top tether strap to prevent it hanging out of the car or being accessible by the child. Do not use the child restraint where this strap may fall into a split in the seatback or off the side of the seat.

Make sure cup holders (if fitted) do not interfere with closure of the car door.



CAUTION:

CHILDREN CAN BE INJURED OR RESTRAINTS AND TOP TETHER STRAP DAMAGED BY UNSECURED CARGO IN A COLLISION. SECURE OR REMOVE HAZARDOUS CARGO BEFORE USING THIS CHILD RESTRAINT.

HOW TO INSTALL

BOOSTER MODE WITH SEATBELT

- F. Sit the child on the seat.
- G. If the seatbelt buckle is adjustable, adjust the buckle as low as possible away from the child.
- H. Position the lap-sash belt over the child ensuring the lap portion is positioned on the child's thighs. The seatbelt should follow the red seatbelt path labels marked **BOOSTER SEATBELT PATH**. Engage seatbelt buckle and tongue ensuring there are no twists in the belt.

Ensure you have engaged the SecureGuard™ device into the harness buckle.

If the lap belt is not on the child's thighs, shorten the length of the crotch strap, see page 38. Fit the SecureGuard™ device over the lap belt as shown. The SecureGuard™ device must be used at all times in Booster mode.

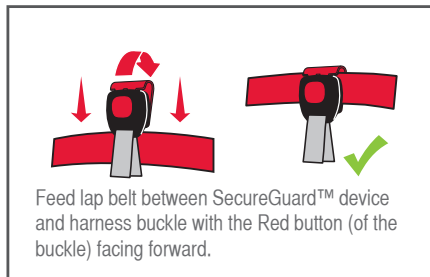
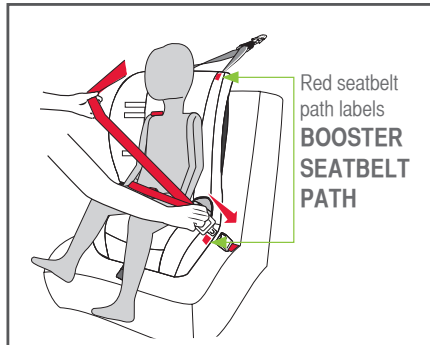

IMPORTANT:

The SecureGuard™ device must be used when the child is using the Booster Seat. Always ensure the seatbelt is across the child's thighs and across the chest.

HOW TO INSTALL

BOOSTER MODE WITH SEATBELT

- I. Place the sash belt across the child's chest and through the sash guide.

The Sash Guide is used to position the sash portion of the lap-sash seatbelt across the child's shoulders and chest.

- J. Adjust the lap portion of the seatbelt firmly across the child and restraint, feed the slack back into the retractor, ensure the sash belt is positioned on the child's shoulders.

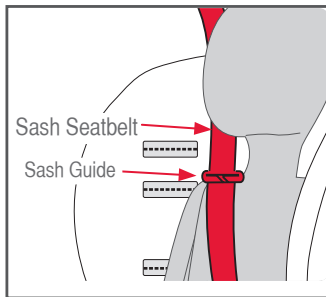
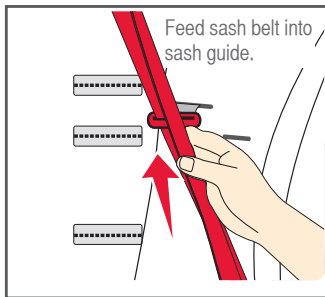
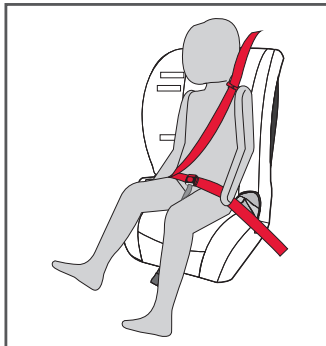

IMPORTANT:

**A SASH BELT UNDER THE ARM OR BEHIND THE BACK IS DANGEROUS.
ALWAYS USE THE SASH GUIDE**



WARNING:

DO NOT LEAVE CHILDREN UNATTENDED IN THE CAR

HOW TO USE

BOOSTER MODE WITH SEATBELT

CHECKLIST - BOOSTER MODE SETUP

- Centre of button on buckle, level with top of thighs.
- Lap belt firmly on hips/thighs.
- SecureGuard™ device fitted to lap belt.
- All slack removed from crotch strap when buckle is in the correct position.
- Sash belt is fitted through sash guide

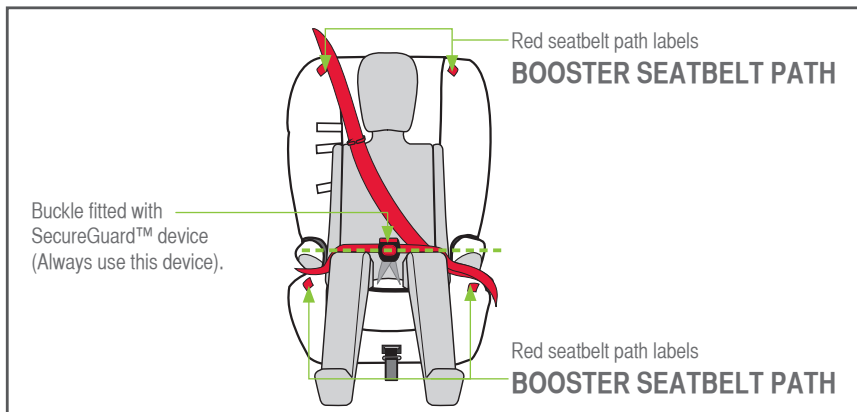

NOTE: Stop using this Booster Seat if the child's shoulders are above the Upper Shoulder Height Marker.



IMPORTANT:

ALWAYS USE THE SecureGuard™ DEVICE

HOW TO USE

BOOSTER MODE WITH SEATBELT

TO STORE SASH GUIDE

When sash guide is not in use, hook the sash guide at the back of the cover to the elastic loop.

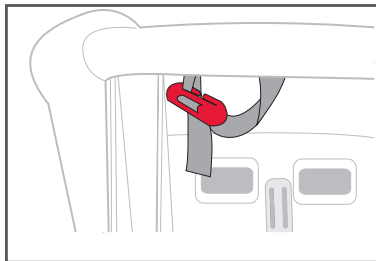
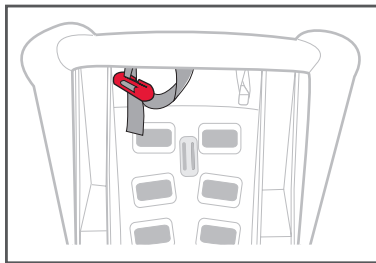

TO REMOVE CHILD

Disengage seatbelt tongue and buckle, remove the lap portion of seatbelt from the SecureGuard™ device and remove belt from child.

When booster is not being used, secure in position, by engaging seatbelt over the booster seat.

CONVERSION TO INBUILT HARNESS USE

BOOSTER MODE WITH SEATBELT

RESTORING THE RESTRAINT FOR TODDLER USE

- A. Store the SecureGuard™ device in the seatbase location provided.
- B. Remove the built-in harness from the storage recess under the cover. Feed crotch strap and shoulder straps through seat cover and shoulder strap slots in the seatback.
- C. Engage harness tongues into buckle. Ensure there are no twists in the straps.
- D. Attach to metal strap connector as shown right.

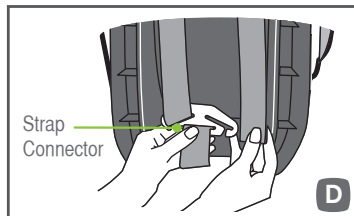

REGULAR CARE OF THIS RESTRAINT:

Please check the following items regularly to ensure the safety of your child:

- A. Check the webbing of the straps for fraying,
- B. Check there are no cracks in moulding,
- C. Check the harness adjuster is operating and is clamping the webbing,
- D. Ensure the buckle is free of fluff, liquid or other matter that may enter the buckle slots. Clean the buckle if it is sluggish to engage. See next page.
- E. If any part of the restraint is cracked or broken, seek repair immediately -
Contact Customer Service 1300 303 330

CLEANING CAR SEAT

HARDWARE: Use only mild soap to clean all metal and plastic parts of your child's restraint, using a damp sponge or cloth. Do not use chemicals or cleaning agents. Do not try and place any hardware into a washing machine.

STRAPS/HARNESS: We recommend spot cleaning straps and harness with a damp sponge or cloth using only cold or warm water. Never place any straps or harness into a washing machine or tumble dryer.

CARE & MAINTENANCE

CARE & MAINTENANCE

BUCKLE OPERATION

To ensure the buckle remains operational, the inside of the buckle must be kept free of liquids, sand, dirt, fluff, food or similar substances. If the buckle is not operating or you do not hear a strong audible click when second tongue is inserted, the buckle needs to be washed or replaced. Contact Customer Service for assistance.

TO CLEAN HARNESS BUCKLE:

If sticky liquids such as baby formula, fruit juice, etc. get inside your harness buckle, it may become sluggish. An indication of a sluggish harness buckle is that you cannot hear a click when engaging the harness tongues. To restore the harness buckle to good working order it needs to be cleaned as follows:

- Remove the harness buckle from the restraint: From the underside of the restraint pull each crotch 3-bar slide then turn the 3-bar slide and push through each slot.
- Place the harness buckle under warm (max. 40 degrees Celsius) running water as shown below. Let the water run through the mouth of the buckle for five minutes. Check the harness buckle is clean by engaging the harness tongues and buckle several times until you hear a click.
- If you still cannot hear a strong audible click then repeat the cleaning process several times.
- Refit the harness buckle to the restraint ensuring the red button facing outwards and the 3-bar slide is fed through the same slots.

If the harness buckle cannot be returned to its original working condition then contact BabyLove® Customer Service for assistance.

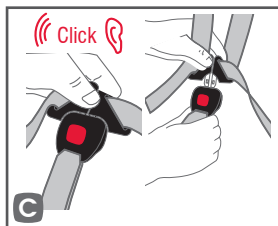
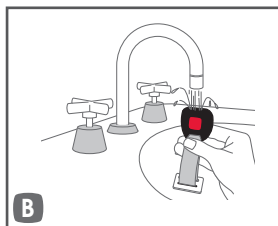
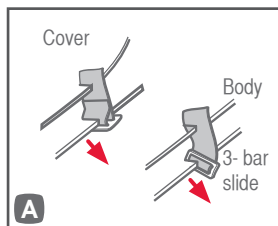

TO CLEAN THE COVER

The restraint has a flame retardant cover which is removable for cleaning. Cleaning instructions are on the care label attached to the cover. When washing cover, engage hook & loop strips together to eliminate other garments being caught. Ensure to keep strips free of lint to work effectively.

The cover has been designed to protect your child when seated in the restraint. Care should be taken if children either eat or drink while in the restraint as some food or drink products may cause damage or marking to the cover. Wash or clean immediately.

Do not pull sticky items from covers as the cover may be damaged - soak in water and gently remove.

To keep your product looking its best, take care while wearing jewellery or other items that could snag.



VERY IMPORTANT:

Only replace the cover with BabyLove® supplied replacement cover with identical shoulder height markers or a replacement cover meeting AS/NZS 8005.

CARE & MAINTENANCE

CARE & MAINTENANCE

TO REMOVE COVER

Follow the sequence below A to G (anti clockwise) to remove the cover.

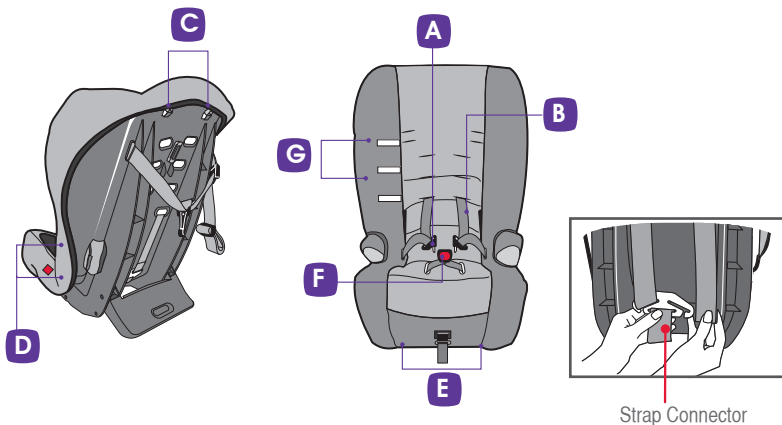

If the sash guide is in Booster Seat mode the sash guide can be left in place for washing.

- A. Disengage harness tongues from crotch buckle.
- B. Unhook the strap connector from the back of the restraint and feed the Shoulder and Lap Harness straps through the cover, (If applicable).
- C. Unhook Elastic Loops.
- D. Peel trim away from seat.
- E. Unhook Elastic Loops from under the restraint.
- F. Feed crotch buckle and harness adjustment strap through slot in cover, (If applicable).
- G. Peel cover away from shell.

REPLACE COVER

To replace cover refit in reverse sequence G to A.

- For the in-built harness or toddler mode, refit the harness through the same shoulder strap slots refer to pages 21 to 23 for harness adjustment and setup.
- For the Booster Seat mode, refit the cover and the sash guide should be in the same position. If the sash guide has fallen out of the slot refit by following the steps on page 40 to 41.

ACCESSORIES & FEATURES

CARE & MAINTENANCE

Use of aftermarket accessories, that is, accessories not provided with this child restraint can reduce the safety of the child restraint and may cause injury or death. Always follow the instructions covering the use of accessories in these instructions or the instructions provided with the accessory. If an aftermarket accessory is used that is not recommended by BabyLove® then ensure that the accessory is for this restraint and compliant with AS/NZS 8005 and is stated as suitable for use with this child restraint.

The following instructions apply to accessories that may be supplied with this restraint at point of purchase. If not, a variety of BRITAX Safe-n-Sound accessories are available from various retailers of BabyLove® products.

CROTCH PAD (IF FITTED)

The Crotch Pad is designed to provide extra comfort for baby or child and is fitted to the restraint as follows: Feed Crotch Buckle through the slot in crotch pad as shown.

PADDED INSERT (IF FITTED)

The Padded Insert is designed to snugly support the baby for extra comfort. Simply place the padded insert on the restraint between Harness straps and the restraint back. Ensure padded insert is lined up with or below the shoulder straps.

Discontinue use if the Insert causes discomfort or when the child's shoulders reach the Middle Shoulder Height Marker. This will allow the child to use the in-built harness longer.

SHOULDER PADS (IF FITTED)

Shoulder Pads are designed to provide extra comfort for baby or child and are easily fitted to the shoulder harness straps by:

- A. Pull apart fasteners and remove shoulder pads from harness.
- B. Re-fit shoulder pads to harness and attach fasteners for use.

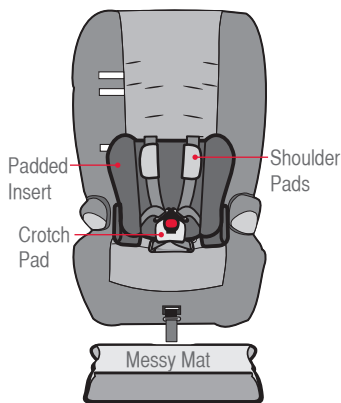

ACCESSORIES & FEATURES

CARE & MAINTENANCE

CUP HOLDERS (IF SUPPLIED)

The Booster Seat has the facility to fit a cup holder on either side of the seat. Fit the cup holder onto the seat to use. Ensure the cup holder and its contents can not be crushed by the car door. Cup Holder can be removed if not in required.



IMPORTANT:

Only use for holding cups, bottles and drink cartons.
Do not use for hot drinks

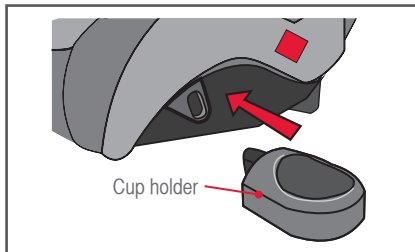

ACCESSORIES & FEATURES

CARE & MAINTENANCE

MESSY MAT SEAT PROTECTOR (IF SUPPLIED)

Place ribbed or pocket end of the Messy Mat seat protector on edge of car seat, smooth back toward seat join ('A') and fit in any excess Messy Mat into the join of the car seat ('A').

Hook and loop attachment referred in some instruction books, are no longer required to fit this model of Messy Mat seat protector.



CAUTION:

The pocket is only for small, light items. **DO NOT** overload the pocket with heavy, bulky items as this may damage the pocket or cause passengers to trip over them.

Short Messy Mat

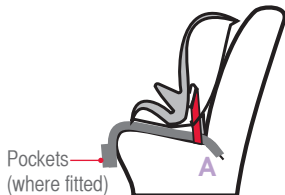

Long Messy Mat

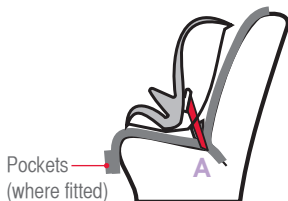

INSTALLATION OF CAR UPPER ANCHORAGE FITTING

CARE & MAINTENANCE

Consult the vehicle owner's handbook for location of anchorage fittings or anchorage points and the possible use of spacers. Some vehicles may have an anchor fitting fitted by the vehicle manufacturer. If anchorage points cannot be found refer to car manufacturer or local child restraint fitting station or traffic authority for preferred position of upper anchorage point.

TOP TETHER STRAP



IMPORTANT:

THE ATTACHMENT CLIP COVER MUST ALWAYS BE USED AS IT PREVENTS THE RISK OF INCORRECT FITMENT OF THE ATTACHMENT CLIP TO THE UPPER ANCHORAGE POINT. ALWAYS ENSURE THAT THE ATTACHMENT CLIP IS CORRECTLY ENGAGED TO THE UPPER ANCHORAGE POINT AND NOT HOOKED OR FITTED TO ANY OTHER OBJECT BEFORE EACH USE OF THE RESTRAINT. THIS IS ESPECIALLY IMPORTANT IN VEHICLES SUCH AS STATION WAGONS, VANS, HATCH BACKS OR VEHICLES WITHOUT A FIXED PARCEL SHELF, SINCE THE ANCHOR POINT IS USUALLY NOT VISIBLE.

IMPORTANT INSTALLATION NOTE:

In some vehicles the upper anchorage point in the rear vertical panel can only be installed in one way. Please refer to vehicle owner's handbook or a child restraint fitting station for correct method.

INSTALLATION OF CAR UPPER ANCHORAGE FITTING

CARE & MAINTENANCE

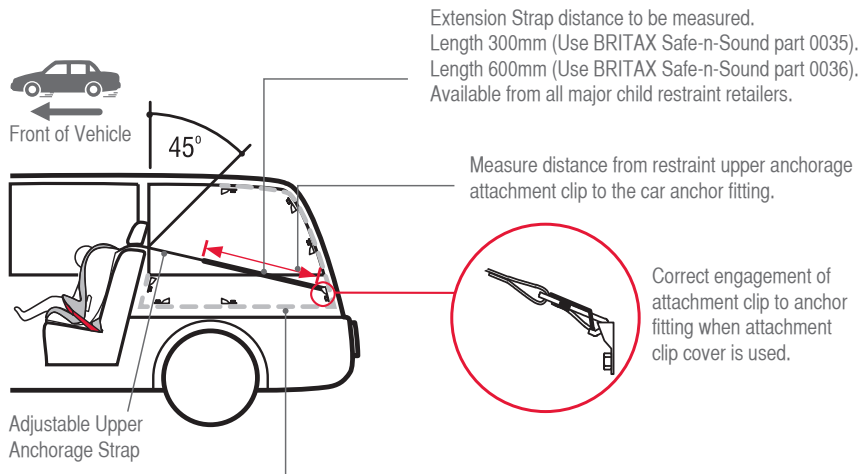

The shaded areas of this diagram illustrate the possible locations of the upper anchorage point (car anchor fitting). Within each shaded area is an upper anchorage point showing the correct way to install the fitting. Ensure the upper anchorage point is aligned as illustrated unless stated otherwise in the vehicle owner's handbook.

INSTALLATION OF CAR UPPER ANCHORAGE FITTING

CARE & MAINTENANCE

IF THE CAR IS FITTED WITH CHILD RESTRAINT UPPER ANCHORAGE POINT

Locate the upper anchorage point behind the rear seating position. (Consult the car owners handbook for the location of the upper anchorage point). The upper anchorage point should be directly behind and central to the restraint. Remove thread plug from the parcel shelf/floor/roof, etc. and install attachment bolt and fitting as shown in Fig 1.

CAUTION: DO NOT OVERTIGHTEN ATTACHMENT BOLT. OVERTIGHTENING MAY FRACTURE OR BREAK BOLT. MAXIMUM TORQUE IS 20 Nm(14.75 ft.lb.)

Note: Minimum of five full turns of attachment bolt is required before tightening force is applied.

IF THE CAR IS NOT FITTED WITH CHILD RESTRAINT UPPER ANCHORAGE POINTS

For Sedans only - Drill 9mm diameter hole in the parcel shelf on the centre line of the seating position as shown in Fig 3. Before drilling the hole, check the underside for accessibility. Install the attachment bolt as shown in Fig 2. It is recommended that this installation be carried out by a child restraint fitting station or licenced motor mechanic.

For vehicles other than Sedans - In Australia, consult your nearest child restraint fitting station or traffic authority for vehicle inspection to find the best, correct position for the placement of the upper anchorage point, and for the correct attachment bolt length and use of spacers. In New Zealand, consult the agent for the vehicle. Note to Queensland purchasers: The installation of anchorage points must be approved by authorised officers appointed by Queensland Transport. Authorised officers can be sourced from all Queensland Transport Customer Service and Queensland Ambulance Service Centres.

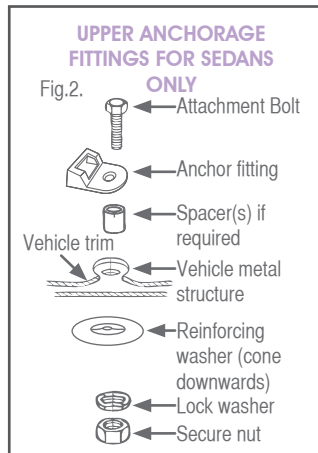
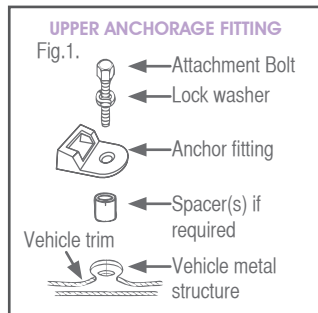

INSTALLATION OF CAR UPPER ANCHORAGE FITTING

CARE & MAINTENANCE

ONLY USE A 5/16 UNC GRADE 5 BOLT. IF THE BOLT IS NOT THE CORRECT LENGTH THE CAR MANUFACTURER'S HAND BOOK CAN PROVIDE ADVICE ON THE CORRECT LENGTH BOLT.



WARNING

CHILD RESTRAINTS MUST NOT BE ATTACHED TO UNSOUND METAL OR TO WOOD, OR SYNTHETIC STRUCTURES. WHEN DRILLING 9 MM HOLE DO NOT DRILL THROUGH FUEL LINES, FUEL TANKS, ELECTRICAL WIRING, OR RADIO SPEAKERS. WEBBING STRAPS MUST BE PROTECTED FROM SHARP CORNERS AND EDGES. THE ANCHOR FITTING MUST BE USED ONLY AS DESCRIBED ABOVE. IT MUST NOT BE HOOKED ONTO ANY OTHER OBJECT.



Note: Marking on the top of a Grade 5 Bolt.



Front of Vehicle

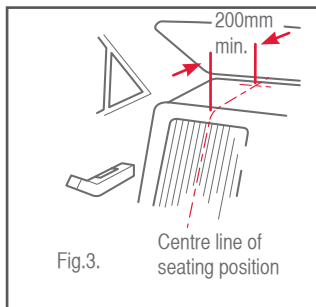

Fig.3.

Centre line of seating position

CAR INSTALLATION ACCESSORIES

(From retailers of Britax Safe-n-Sound products)

EXTRA ANCHOR KITS: Available for using the restraint in additional cars.

Re-order no: 0289

EXTENSION STRAPS: May be required for cars without a fixed parcel shelf.

Re-order no: 0291 (length 300mm) or

0290 (length 600mm)

IN CASE OF ACCIDENT

If your restraint has been involved in a severe crash, you should destroy the restraint even if no damage is obvious. Some insurance companies offer vehicle insurance which covers or partially covers the replacement of your child restraint. Contact your insurance company for further details.

Your insurance company may require you to keep the child restraint for assessment, **but do not use the child restraint after a severe crash.**

NOTES



WARRANTY

Our goods come with guarantees that cannot be excluded under the Australian Consumer Law. You are entitled to a replacement or refund for a major failure and compensation for any other reasonable foreseeable loss or damage. You are also entitled to have the goods repaired or replaced if the goods fail to be acceptable quality and the failure does not amount to a major failure.

For the full terms of the Warranty refer to the BabyLove® website www.babylove.com.au/warranty

AUSTRALIA

Phone number: 1300 131 477

NEW ZEALAND

Phone number: 0508 688 822

www.babylove.com.au

Britax Childcare Pty Ltd.
A.B.N 55 006 773 600
Level 4, 650 Lorimer Street,
Port Melbourne, Victoria
Australia 3207

In our constant pursuit of excellence we may alter this product and specification without notice.

This product may be covered by Australian and International patents and designs or pending applications.

BabyLove® is a registered trademark and all BabyLove® model names are trademarks of Britax Childcare Pty Ltd

baby 
love®